

General data sheet

# Oil Nozzles Type KH

For specific information on this product, please contact Danfoss Burner Components

**Identification**

The nozzle is marked with the following information:

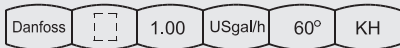

[ ]	Serial number for internal use
1.00	Reference capacity (USgal/h)
Specification point:	700 kPa (7 bar), 1.7 cSt., 790 kg/m <sup>3</sup> Capacity tolerance: ± 5%
60°	Spray angle
KH	Spray pattern (KH = Kerosene Hollow)

Oil nozzles type KH are designed for domestic high-pressure oil burners on the Japanese market operating with kerosene. They are available with spray angle 60°, spray pattern H and sizes from 0.4 to 1.75 USgal/h. The nozzles are equipped with sintered bronze filters.

**Application and Features**

- Kerosene
- 100% test of capacity and performance

**Design**

- A Nozzle housing
- B Bottom screw
- C Nozzle cone
- D Orifice disc
- H Filter

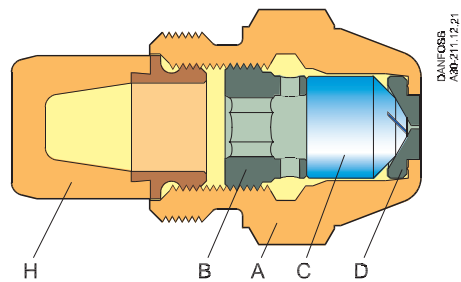

**Spray angles**

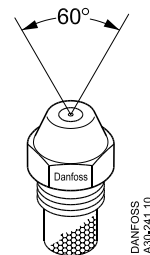

**Spray pattern**

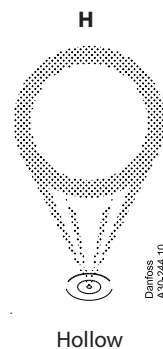

General data sheet

Oil Nozzles Type KH

Technical Data

Filters

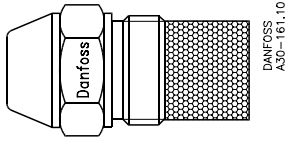

Capacity 0.40-0.65 USgal/h:  
45 µm sintered bronze

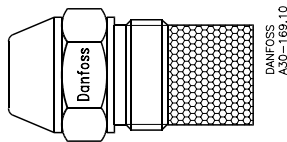

Capacity 0.75-1.35 USgal/h:  
75 µm sintered bronze

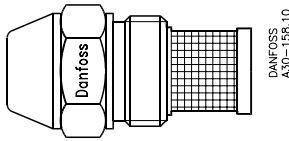

Capacity 1.40-1.75 USgal/h:  
140 µm monel mesh

Tightening torques

Recommended tightening torque	15 to 20 Nm (1.5 to 2.0 kpm)
Max. tightening torque	25 Nm (2.5 kpm)

Oil Nozzles Type KH

Reference capacity USgal/h	Spray angle/patterns	Specified capacity l/h
0.40	60°H	1.40
0.50	60°H	1.81
0.65	60°H	2.30
0.75*	60°H	2.70
0.85	60°H	3.30
1.00	60°H	3.80
1.10	60°H	4.05
1.20	60°H	4.25
1.25	60°H	4.35
1.35	60°H	4.80
1.40	60°H	5.15
1.50	60°H	5.70
1.75	60°H	6.30

\*Nozzles marked KHf have 45 µm sintered bronze filter.

Dimensions

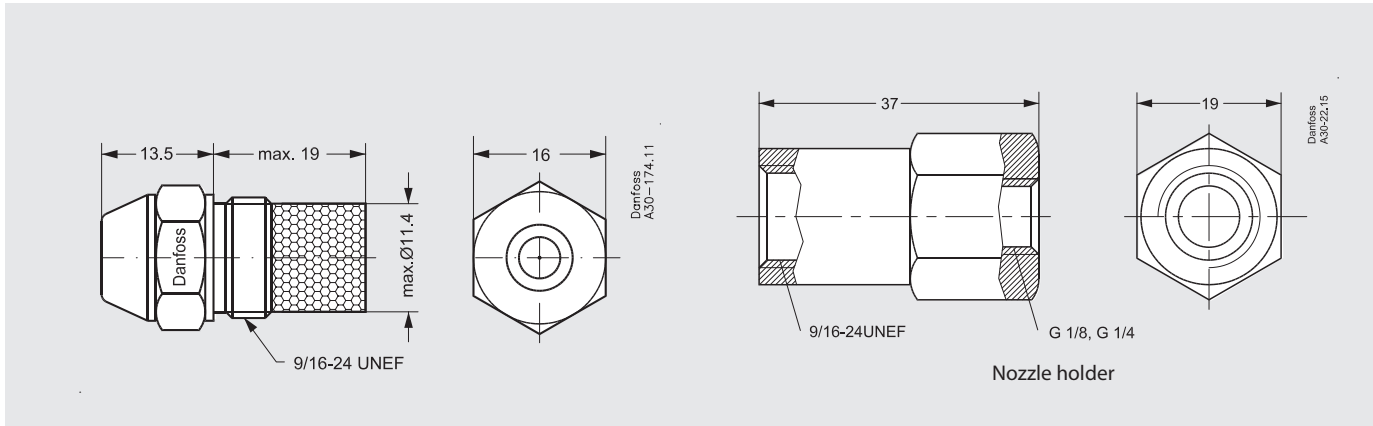

Additional documentation on burner components is available on <http://heating.danfoss.com/> or <https://store.danfoss.com/>

Danfoss A/S

Heating Segment • heating.danfoss.com • +45 7488 2222 • E-Mail: heating@danfoss.com

Danfoss can accept no responsibility for possible errors in catalogues, brochures and other printed material. Danfoss reserves the right to alter its products without notice. This also applies to products already on order provided that such alterations can be made without consequential changes being necessary in specifications already agreed. All trademarks in this material are property of the respective companies. Danfoss and all Danfoss logotypes are trademarks of Danfoss A/S. All rights reserved.