

<https://www.wago.com/249-116>

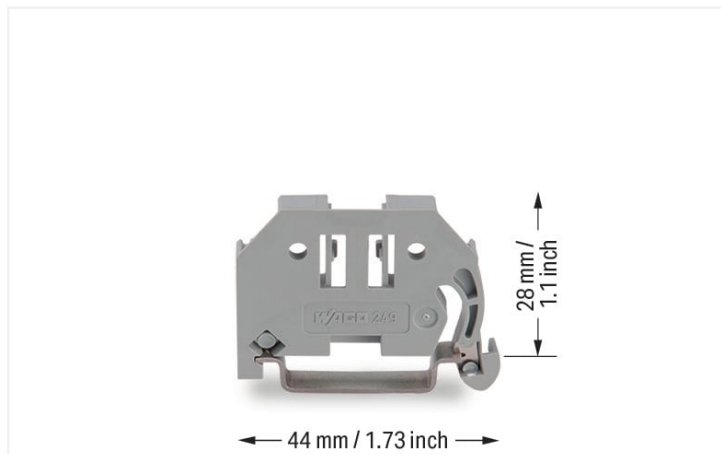

Color: gray

Notes

Note

Snap on – that's it!

Assembling the new WAGO screwless end stop is as simple and quick as snapping a WAGO rail-mount terminal block onto the rail.

Tool free!

A tool-free design allows rail-mount terminal blocks to be safely and economically secured against any movement on all DIN-35 rails per DIN EN 60715 (35 x 7.5 mm; 35 x 15 mm).

Entirely without screws!

The "secret" to a perfect fit lies in the two small clamping plates which keep the end stop in position, even if the rails are mounted vertically.

Simply snap on – that's it!

In addition, costs are significantly reduced when using large numbers of end stops. Additional benefit: Three marker slots for all WAGO rail-mount terminal block markers and one snap-in hole for WAGO adjustable height group marker carriers offer individual marking options.

Technical data

| | |
|-----------------------|----------------------|
| Main product function | Mounting accessories |
| Mounting type | DIN-35 rail |

Physical data

| | |
|-----------------------------------|----------------------|
| Width | 6 mm / 0.236 inches |
| Height | 44 mm / 1.732 inches |
| Depth | 35 mm / 1.378 inches |
| Depth from upper-edge of DIN-rail | 28 mm / 1.102 inches |

Material Data

| | |
|-----------------------------|------------------|
| Color | gray |
| Insulation material | Polyamide (PA66) |
| Flammability class per UL94 | V0 |
| Fire load | 0.104 MJ |
| Weight | 3.5 g |

| Commercial data | |
|-----------------------|--------------------------------|
| Product Group | 2 (Terminal Block Accessories) |
| eCl@ss 10.0 | 27-14-11-35 |
| eCl@ss 9.0 | 27-14-11-35 |
| ETIM 8.0 | EC001041 |
| ETIM 7.0 | EC001041 |
| PU (SPU) | 100 (25) pcs |
| Packaging type | Box |
| Country of origin | CN |
| GTIN | 4017332270823 |
| Customs tariff number | 39269097900 |

Downloads

Environmental Product Compliance

| Compliance Search | |
|------------------------------------------|-------------------|
| Environmental Product Compliance 249-116 | ↓ |

Documentation

| Bid Text | | | |
|----------|------------|-----------------|-------------------|
| 249-116 | 19.02.2019 | xml 2.66 KB | ↓ |
| 249-116 | 31.08.2017 | doc 23.50 KB | ↓ |

CAD/CAE-Data

| CAD data | |
|----------------------|-------------------|
| 2D/3D Models 249-116 | ↓ |











| CAE data | |
|---------------------------|-------------------|
| EPLAN Data Portal 249-116 | ↓ |
| WSCAD Universe 249-116 | ↓ |
| ZUKEN Portal 249-116 | ↓ |

1 Compatible Products



1.1 Optional Accessories

1.1.1 Marking





























1.1.1.1 Group marker carrier

| | | | |
|----------------------------------------------------------------------------------------------------------------------------------------------|----------------------------------------------------------------------------------------------------------------------------------------------|----------------------------------------------------------------------------------------------------------------------------------------------|-----------------------------------------------------------------------------------------------------------------------------------------------|
|  Item No.: 2009-163 Group marker carrier; gray |  Item No.: 209-140 Group marker carrier; gray |  Item No.: 209-141 Group marker carrier; gray |  Item No.: 209-142 Group marker carrier; gray |
|  Item No.: 249-105 Group marker carrier; gray |  Item No.: 249-118 Group marker carrier; gray |  Item No.: 249-119 Group marker carrier; gray |  Item No.: 709-118 Group marker carrier; gray |
|  Item No.: 709-119 Group marker carrier; gray |  Item No.: 209-112 Group marker carrier; white |  Item No.: 249-120 Group marker carrier; white | |

1.1.1.2 Label

| | |
|----------------------------------------------------------------------------------------------------------------------------------------------------------------|--------------------------------------------------------------------------------------------------------------------------------------------------------------|
|  Item No.: 210-808 Labels; for Smart Printer; 9.5 x 25 mm; white |  Item No.: 210-708 Labels; for TP printers; 9.5 x 25 mm; white |
|----------------------------------------------------------------------------------------------------------------------------------------------------------------|--------------------------------------------------------------------------------------------------------------------------------------------------------------|

1.1.1.3 Marker

| | | | |
|-------------------------------------------------------------------------------------------------------------------------------------------------------------------------------------------------------------------------------------------------------|--------------------------------------------------------------------------------------------------------------------------------------------------------------------------------------------------------------------------------------------------|-------------------------------------------------------------------------------------------------------------------------------------------------------------------------------------------------------------------------------------------------|----------------------------------------------------------------------------------------------------------------------------------------------------------------------------------------------------------------------------------------------------|
|  Item No.: 2009-145/000-006 Mini-WSB Inline; for Smart Printer; 1700 pieces on roll; stretchable 5 - 5.2 mm; plain; snap-on type; blue |  Item No.: 2009-145/000-007 Mini-WSB Inline; for Smart Printer; 1700 pieces on roll; stretchable 5 - 5.2 mm; plain; snap-on type; gray |  Item No.: 2009-145/000-023 Mini-WSB Inline; for Smart Printer; 1700 pieces on roll; stretchable 5 - 5.2 mm; plain; snap-on type; green |  Item No.: 2009-145/000-012 Mini-WSB Inline; for Smart Printer; 1700 pieces on roll; stretchable 5 - 5.2 mm; plain; snap-on type; orange |
|  Item No.: 2009-145/000-005 Mini-WSB Inline; for Smart Printer; 1700 pieces on roll; stretchable 5 - 5.2 mm; plain; snap-on type; red |  Item No.: 2009-145/000-024 Mini-WSB Inline; for Smart Printer; 1700 pieces on roll; stretchable 5 - 5.2 mm; plain; snap-on type; violet |  Item No.: 2009-145 Mini-WSB Inline; for Smart Printer; 1700 pieces on roll; stretchable 5 - 5.2 mm; plain; snap-on type; white |  Item No.: 2009-145/000-002 Mini-WSB Inline; for Smart Printer; 1700 pieces on roll; stretchable 5 - 5.2 mm; plain; snap-on type; yellow |
|  Item No.: 248-501/000-006 Mini-WSB marking card; as card; not stretchable; plain; snap-on type; blue |  Item No.: 248-501/000-007 Mini-WSB marking card; as card; not stretchable; plain; snap-on type; gray |  Item No.: 248-501/000-023 Mini-WSB marking card; as card; not stretchable; plain; snap-on type; green |  Item No.: 248-501/000-017 Mini-WSB marking card; as card; not stretchable; plain; snap-on type; light green |
|  Item No.: 248-501/000-012 Mini-WSB marking card; as card; not stretchable; plain; snap-on type; orange |  Item No.: 248-501/000-005 Mini-WSB marking card; as card; not stretchable; plain; snap-on type; red |  Item No.: 248-501/000-024 Mini-WSB marking card; as card; not stretchable; plain; snap-on type; violet |  Item No.: 248-501 Mini-WSB marking card; as card; not stretchable; plain; snap-on type; white |
|  Item No.: 248-501/000-002 Mini-WSB marking card; as card; not stretchable; plain; snap-on type; yellow |  Item No.: 793-5501/000-006 WMB marking card; as card; for terminal block width 5 - 17.5 mm; stretchable 5 - 5.2 mm; plain; snap-on type; blue |  Item No.: 793-5501/000-007 WMB marking card; as card; for terminal block width 5 - 17.5 mm; stretchable 5 - 5.2 mm; plain; snap-on type; gray |  Item No.: 793-5501/000-023 WMB marking card; as card; for terminal block width 5 - 17.5 mm; stretchable 5 - 5.2 mm; plain; snap-on type; green |
|  Item No.: 793-5501/000-017 WMB marking card; as card; for terminal block width 5 - 17.5 mm; stretchable 5 - 5.2 mm; plain; snap-on type; light green |  Item No.: 793-5501/000-012 WMB marking card; as card; for terminal block width 5 - 17.5 mm; stretchable 5 - 5.2 mm; plain; snap-on type; orange |  Item No.: 793-5501/000-005 WMB marking card; as card; for terminal block width 5 - 17.5 mm; stretchable 5 - 5.2 mm; plain; snap-on type; red |  Item No.: 793-5501/000-024 WMB marking card; as card; for terminal block width 5 - 17.5 mm; stretchable 5 - 5.2 mm; plain; snap-on type; violet |
|  Item No.: 793-5501 WMB marking card; as card; for terminal block width 5 - 17.5 mm; stretchable 5 - 5.2 mm; plain; snap-on type; white |  Item No.: 793-5501/000-002 WMB marking card; as card; for terminal block width 5 - 17.5 mm; stretchable 5 - 5.2 mm; plain; snap-on type; yellow |  Item No.: 793-501/000-006 WMB marking card; as card; not stretchable; plain; snap-on type; blue |  Item No.: 793-501/000-007 WMB marking card; as card; not stretchable; plain; snap-on type; gray |

1.1.1.3 Marker



Item No.: 793-501/000-023

WMB marking card; as card; not stretchable; plain; snap-on type; green

Item No.: 793-501/000-017

WMB marking card; as card; not stretchable; plain; snap-on type; light green

Item No.: 793-501/000-012

WMB marking card; as card; not stretchable; plain; snap-on type; orange

Item No.: 793-501/000-005

WMB marking card; as card; not stretchable; plain; snap-on type; red



Item No.: 793-501/000-024

WMB marking card; as card; not stretchable; plain; snap-on type; violet

Item No.: 793-501

WMB marking card; as card; not stretchable; plain; snap-on type; white

Item No.: 793-501/000-002

WMB marking card; as card; not stretchable; plain; snap-on type; yellow

Item No.: 2009-115/000-006

WMB-Inline; for Smart Printer; 1500 pieces on roll; stretchable 5 - 5.2 mm; plain; snap-on type; blue



Item No.: 2009-115/000-007

WMB-Inline; for Smart Printer; 1500 pieces on roll; stretchable 5 - 5.2 mm; plain; snap-on type; gray

Item No.: 2009-115/000-023

WMB-Inline; for Smart Printer; 1500 pieces on roll; stretchable 5 - 5.2 mm; plain; snap-on type; green

Item No.: 2009-115/000-017

WMB-Inline; for Smart Printer; 1500 pieces on roll; stretchable 5 - 5.2 mm; plain; snap-on type; light green

Item No.: 2009-115/000-012

WMB-Inline; for Smart Printer; 1500 pieces on roll; stretchable 5 - 5.2 mm; plain; snap-on type; orange



Item No.: 2009-115/000-024

WMB-Inline; for Smart Printer; 1500 pieces on roll; stretchable 5 - 5.2 mm; plain; snap-on type; violet

Item No.: 2009-115

WMB-Inline; for Smart Printer; 1500 pieces on roll; stretchable 5 - 5.2 mm; plain; snap-on type; white

Item No.: 2009-115/000-002

WMB-Inline; for Smart Printer; 1500 pieces on roll; stretchable 5 - 5.2 mm; plain; snap-on type; yellow

Installation Notes

Installation

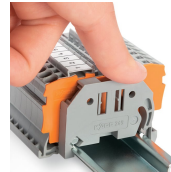
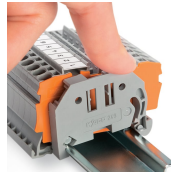

Snap-on mounting

That's it!

Removing an end stop from the DIN-rail.