

# Product datasheet

Specifications



7" wide screen touch panel, 16M colors, COM x 2, ETH x 1, USB host / device, RTC, DC24V

HMIET6400

## Main

Range of product	Easy Harmony ET6
Product or component type	Touch panel screen
Software designation	Vijeo Designer Basic
Operating system	VxWorks
Processor name	ARM Cortex-A8

## Complementary

Display size	7 inch
Display type	Colour TFT LCD
Display colour	16 million colours
Display resolution	800 x 480 pixels WVGA
Touch panel	Single touch analogue resistive
Brightness	16 levels
Character font	ASCII ASCII (European characters) Chinese (simplified Chinese) Japanese (ANK, Kanji) Katakana Korean Taiwanese (traditional Chinese)
[Us] rated supply voltage	24 V DC +/- 20 %
Inrush current	30 A
Local signalling	Status LED green, steady for operating Status LED orange, steady for software starting up Status LED red, steady for power supply (ON) Status LED, off for power supply (OFF)
Power consumption in W	9 W
Number of pages	200 application pages
Processor frequency	800 MHz
Port Ethernet	10/100BASE
Memory description	Device memory 256 MB User data memory 256 MB Backup memory 128 kB
Integrated connection type	1 COM1 serial link - 1 SUB-D 9-pin male - RS232C (rate: 2400...115200 bps)bottom 1 COM2 serial link - 1 SUB-D 9-pin male - RS422/RS485 (rate: 2400...115200 bps)bottom COM2 serial link (rate: 2400...187500 bps)bottom 1 Ethernetbottom

Disclaimer: This documentation is not intended as a substitute for and is not to be used for determining suitability or reliability of these products for specific user applications

	1 USB 2.0 type A back 1 USB 2.0 type micro B back
<b>Supply</b>	External supply
<b>Realtime clock</b>	Built-in 0...50 °C Built-in 10...90 % RH
<b>Downloadable protocols</b>	Modbus Uni-TE Third party protocols
<b>Product brand</b>	Schneider Electric
<b>Fixing mode</b>	By 4 screws, mounting on 1.6...5 mm thick panel
<b>Cut-out dimensions</b>	190 x 135 mm panel cut dimension
<b>Height</b>	151 mm
<b>Width</b>	206 mm
<b>Depth</b>	45 mm
<b>Net weight</b>	0.61 kg

## Environment

<b>Immunity to microbreaks</b>	5 ms
<b>Enclosure material</b>	PC
<b>Front material</b>	Plastic
<b>Standards</b>	EN 61000-6-4 EN 61000-6-2 EN 61131-2 UL 61010-2-201 CSA C22.2 No 61010-1-201
<b>Product certifications</b>	CE UL EAC (pending) KC-Mark (pending)
<b>Directives</b>	2014/35/EU - low voltage directive 2014/30/EU - electromagnetic compatibility
<b>Ambient air temperature for operation</b>	0...50 °C
<b>Ambient air temperature for storage</b>	-20...60 °C
<b>Relative humidity</b>	10...90 % non-condensing
<b>Operating altitude</b>	2000 m
<b>IP degree of protection</b>	IP20 (rear panel) conforming to IEC 61131-2 IP65 (front panel) conforming to IEC 61131-2
<b>Shock resistance</b>	147 m/s <sup>2</sup> for 11 ms (X, Y, Z directions for 3 times) conforming to EN/IEC 61131-2
<b>Vibration resistance</b>	+/- 3.5 mm (f = 5...9 Hz) X, Y, Z directions for 10 cycles (approx. 100 min) conforming to EN/IEC 61131-2 9.8 m/s <sup>2</sup> (f = 9...150 Hz)
<b>Electromagnetic compatibility</b>	Electrical fast transient/burst immunity test - test level: 2 kV (power ports) conforming to IEC 61000-4-4 Electrical fast transient/burst immunity test - test level: 1 kV (signal ports) Electrostatic discharge immunity test - test level: 6 kV (contact discharge) conforming to EN/IEC 61000-4-2 level 3 Electrostatic discharge immunity test - test level: 8 kV (air discharge)

## Packing Units

<b>Unit Type of Package 1</b>	PCE
<b>Number of Units in Package 1</b>	1
<b>Package 1 Height</b>	8.5 cm
<b>Package 1 Width</b>	19.0 cm
<b>Package 1 Length</b>	28.2 cm

<b>Package 1 Weight</b>	904.0 g
<b>Unit Type of Package 2</b>	S03
<b>Number of Units in Package 2</b>	6
<b>Package 2 Height</b>	30.0 cm
<b>Package 2 Width</b>	30.0 cm
<b>Package 2 Length</b>	40.0 cm
<b>Package 2 Weight</b>	6.153 kg

## Offer Sustainability

<b>Sustainable offer status</b>	Green Premium product
<b>REACH Regulation</b>	<a href="#">REACH Declaration</a>
<b>EU RoHS Directive</b>	Compliant <a href="#">EU RoHS Declaration</a>
<b>Mercury free</b>	Yes
<b>China RoHS Regulation</b>	<a href="#">China RoHS declaration</a>
<b>RoHS exemption information</b>	Yes
<b>Environmental Disclosure</b>	<a href="#">Product Environmental Profile</a>
<b>Circularity Profile</b>	<a href="#">End of Life Information</a>
<b>WEEE</b>	The product must be disposed on European Union markets following specific waste collection and never end up in rubbish bins

**Dimensions**

**External Dimensions**

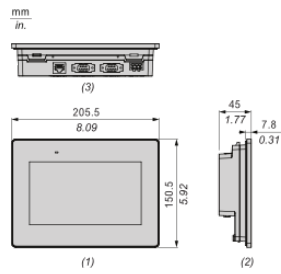

- (1): Front
- (2): Left
- (3): Bottom

**Dimensions with Installation Fasteners**

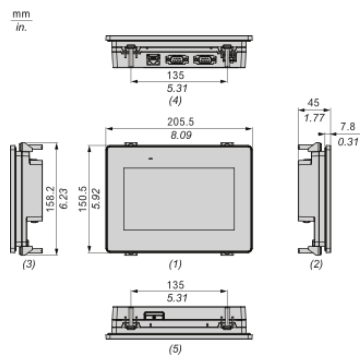

- (1): Front
- (2): Left
- (3): Right
- (4): Bottom
- (5): Top

**Dimensions with Cables**

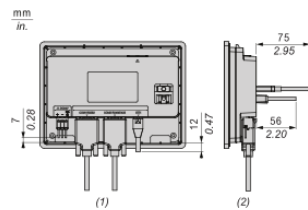

- (1): Back
- (2): Left

**Mounting**

**Panel Cut Dimension**

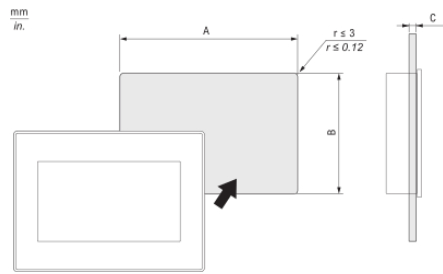

A		B		C	
mm	in.	mm	in.	mm	in.
190 (+1, -0)	7.48 (+0.04, -0)	135 (+1, -0)	5.31 (+0.04, -0)	1.6...5	0.06...0.2

**Mounting Orientation**

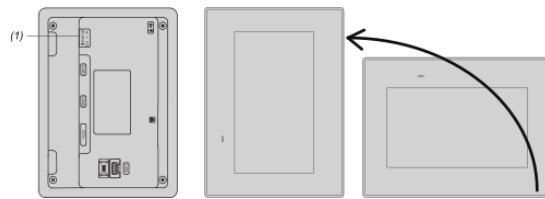

(1): Power connector

**Note:** For portrait orientation mounting, make sure the screen editing software supports the function.

**Mounting Angle**

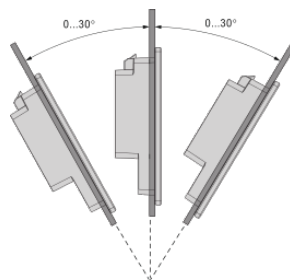

**Clearance**

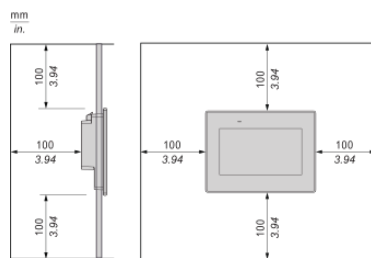

**Recommended replacement(s)**