

CX-400 SERIES Ver.2

- FIBER SENSORS
- LASER SENSORS
- PHOTOELECTRIC SENSORS
- MICRO PHOTOELECTRIC SENSORS
- AREA SENSORS
- SAFETY LIGHT CURTAINS / SAFETY COMPONENTS
- PRESSURE / FLOW SENSORS
- INDUCTIVE PROXIMITY SENSORS
- PARTICULAR USE SENSORS
- SENSOR OPTIONS
- SIMPLE WIRE- SAVING UNITS
- WIRE- SAVING SYSTEMS
- MEASUREMENT SENSORS
- STATIC CONTROL DEVICES
- LASER MARKERS
- PLC
- HUMAN MACHINE INTERFACES
- ENERGY MANAGEMENT SOLUTIONS
- FA COMPONENTS
- MACHINE VISION SYSTEMS
- UV CURING SYSTEMS

Related Information

- General terms and conditions F-3
- Selection guide..... P.231~
- MS-AJ / CHX-SC2 P.953 / P.959
- Glossary of terms..... P.1549~
- General precautions..... P.1552~
- Korea's S-mark P.1602

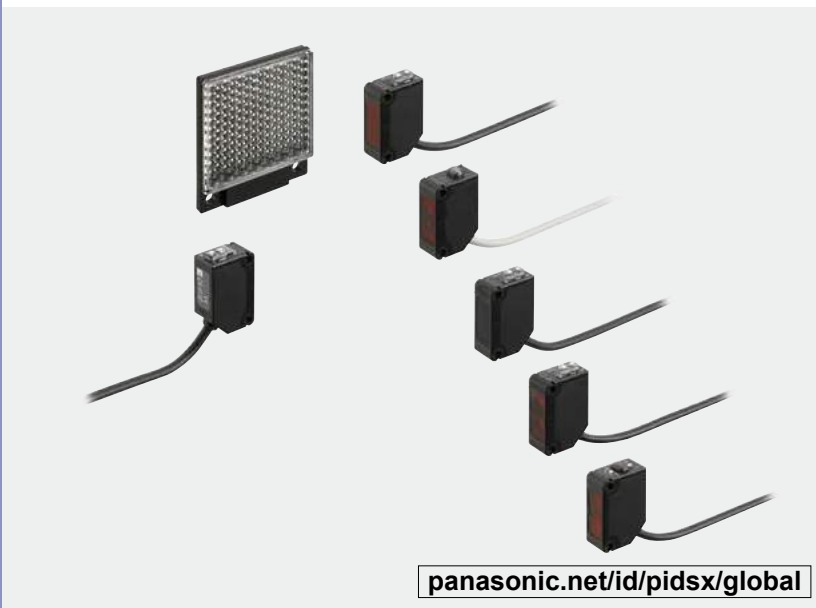

panasonic.net/id/pidsx/global

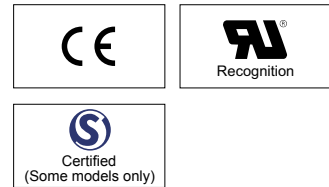

Sensors that are environmentally and user friendly.

Reducing environmental burdens further Up to 60% less power consumption

The various lineup covers through the inclusion of a newly developed custom integrated circuit. The CX-400 series achieves reductions in power consumption of up to 60%, averaging 44% reduction when upgrading due to its unique design. These sensors reduce carbon emissions and contribute to environmental friendliness.

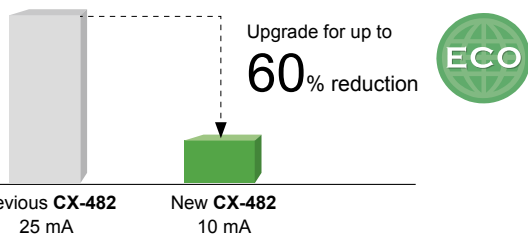
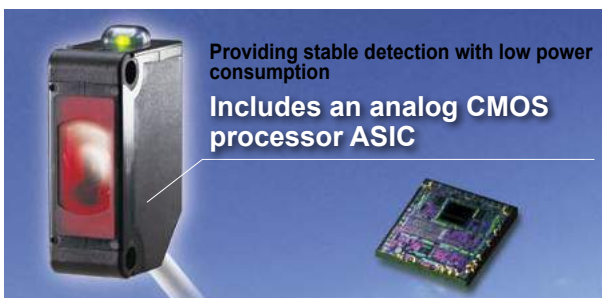

Contributing to reduced carbon dioxide emissions

Electricity consumed by the CX-400 series has been reduced on average 10.5 mA. Calculating 8 hours/day, 260 days (operating 5 days/week) for a total of 2,080 hours/year leads to:

▶ The CX-400 contributes

Approx. 84.6 t annually in carbon dioxide reductions to the world

Strong against oil and coolant liquids **CX-41□/42□/49□**

The lens material for the thru-beam type, retroreflective type (excluding the CX-48□) and the diffuse reflective type are made of a strong acrylic that resists the harmful effects of coolants. These sensors can be used with confidence even around metal processing machinery that disperses oil mists. The protection mechanism also conforms to IP67 (IEC).

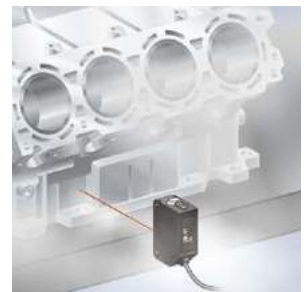

| Test Oil | JIS Standard | Product Name |
|-----------------------------|--------------|-----------------------------|
| Lubricant | - | Velocity Oil No. 3 |
| Water-insoluble cutting oil | 2-5 | Daphnecut AS-30D |
| | 2-11 | Yushiron Oil No.2ac (Note) |
| Water-soluble cutting oil | W1-1 | Yushiron Lubic HWC68 (Note) |
| | W2-1 | Yushiroken S50N (Note) |

1,000 hours; Immersion (depth 0 m); Insulation resistance 20 MΩ/250 V
Note: Yushiron and Yushiroken are registered trademarks of Yushiro Chemical Industry Co., Ltd.

Strong against ethanol **CX-44□/48□**

A strong, ethanol resistant polycarbonate was used for the front and display covers. Safe even for installing near food processing machinery that disperses ethanol based detergents. The protection mechanism also conforms to IP67 (IEC).



Caution: Set the CX-48□ so that cleaning liquid will not get on to the attached reflector.

- Selection Guide
- Amplifier Built-in
- Power Supply Built-in
- Amplifier-separated
- EX-Z
- CX-400
- CY-100
- EX-10
- EX-20
- EX-30
- EX-40
- CX-440
- EQ-30
- EQ-500
- MQ-W
- RX-LS200
- RX
- RT-610

APPLICATIONS

Detecting out of position tape feeder cassette

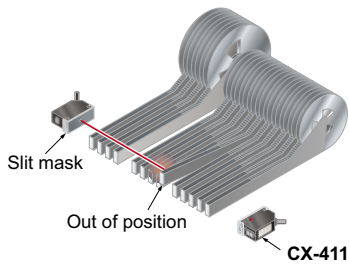

Detecting objects in dusty environment

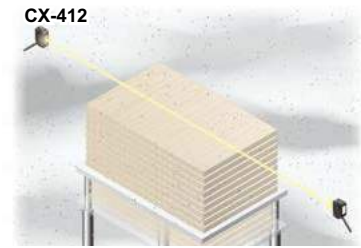

Passage confirmation of object on a conveyor belt

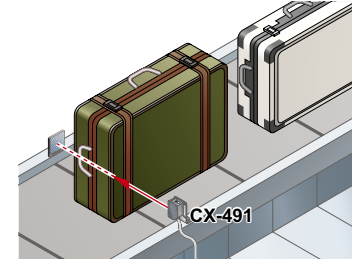

Detecting transparent glass bottles

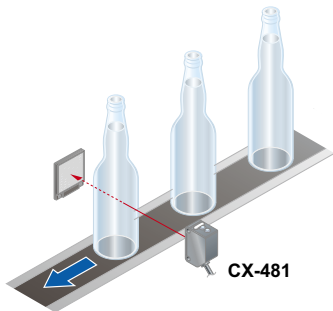

Detecting a small tablet

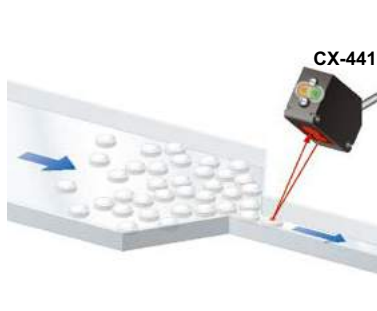

Detecting a biscuit

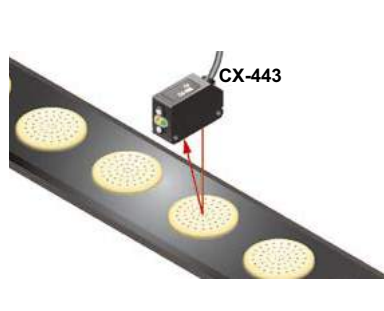

BASIC PERFORMANCE

Strong infrared beam

CX-412/413

Remarkable penetrating power enables applications such as package content detection.

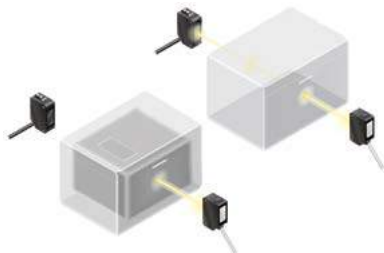

Note: When sensing utilizing penetrating power, make sure to verify using the actual sensor.

Can sense differences as small as 0.4 mm 0.016 in, with hysteresis of 2 % or less

CX-441/443

An advanced optical system provides sensing performance that is 2.5 times approx. than conventional models. Even ultra-small differences of 0.4 mm 0.016 in can be detected accurately.

2.5 times the sensing capability!

Height differences of as little as 0.4 mm 0.016 in can be detected at a setting distance of 20 mm 0.787 in



Hardly affected by colors

CX-441/443

Both black and white objects can be sensed at the same distances. No adjuster control is needed, even when products of different colors are moving along the production line.

30 % higher sensing capability



[The difference in sensing ranges is 1% or less between non-glossy white paper with a setting distance of 50 mm 1.969 in and non-glossy gray paper with a brightness level of 5.]

Retroreflective type with polarizing filters

CX-491

Built-in polarizing filters ensure stable sensing even on a specular object.

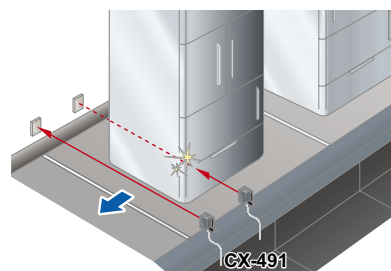

FIBER SENSORS

LASER SENSORS

PHOTOELECTRIC SENSORS

MICRO PHOTOELECTRIC SENSORS

AREA SENSORS

SAFETY LIGHT CURTAINS / SAFETY COMPONENTS

PRESSURE / FLOW SENSORS

INDUCTIVE PROXIMITY SENSORS

PARTICULAR USE SENSORS

SENSOR OPTIONS

SIMPLE WIRE-SAVING UNITS

WIRE-SAVING SYSTEMS

MEASUREMENT SENSORS

STATIC CONTROL DEVICES

LASER MARKERS

PLC

HUMAN MACHINE INTERFACES

ENERGY MANAGEMENT SOLUTIONS

FA COMPONENTS

MACHINE VISION SYSTEMS

UV CURING SYSTEMS

Selection Guide

Amplifier Built-in

Power Supply Built-in

Amplifier-separated

EX-Z

CX-400

CY-100

EX-10

EX-20

EX-30

EX-40

CX-440

EQ-30

EQ-500

MQ-W

RX-LS200

RX

RT-610

- FIBER SENSORS
- LASER SENSORS
- PHOTOELECTRIC SENSORS
- MICRO PHOTOELECTRIC SENSORS
- AREA SENSORS
- SAFETY LIGHT CURTAINS / SAFETY COMPONENTS
- PRESSURE / FLOW SENSORS
- INDUCTIVE PROXIMITY SENSORS
- PARTICULAR USE SENSORS
- SENSOR OPTIONS
- SIMPLE WIRE-SAVING UNITS
- WIRE-SAVING SYSTEMS
- MEASUREMENT SENSORS
- STATIC CONTROL DEVICES
- LASER MARKERS
- PLC
- HUMAN MACHINE INTERFACES
- ENERGY MANAGEMENT SOLUTIONS
- FA COMPONENTS
- MACHINE VISION SYSTEMS
- UV CURING SYSTEMS
- Selection Guide
- Amplifier Built-in
- Power Supply Built-in
- Amplifier-separated
- EX-Z
- CX-400
- CY-100
- EX-10
- EX-20
- EX-30
- EX-40
- CX-440
- EQ-30
- EQ-500
- MQ-W
- RX-LS200
- RX
- RT-610

BASIC PERFORMANCE

Introducing the transparent object sensing type sensor

CX-48□

Our unique optical system and transparent object sensing circuitry provide stable sensing of even thinner transparent objects than the conventional models.

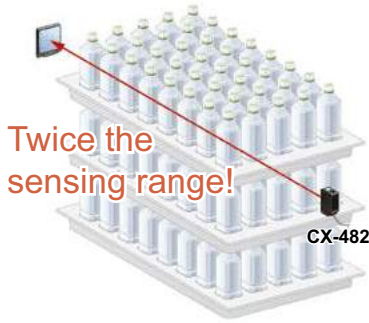

Transparent objects detectable with **CX-48□** (Typical examples)

| Sensing object | Sensing object size (mm in) |
|----------------------|---|
| Glass sheet | 50 × 50 1.969 × 1.969 t = 0.7 0.028 |
| Cylindrical glass | ø50 ø1.969 ℓ = 50 1.969 t = 1.3 0.051 |
| Acrylic board | 50 × 50 1.969 × 1.969 t = 1.0 0.039 |
| Styrol (Floppy case) | 50 × 50 1.969 × 1.969 t = 0.9 0.035 |
| Food wrapping film | 50 × 50 1.969 × 1.969 t = 10 μm 0.394 mil |
| Cigarette case film | 50 × 50 1.969 × 1.969 t = 20 μm 0.787 mil |
| Vinyl sack | 50 × 50 1.969 × 1.969 t = 30 μm 1.181 mil |
| PET bottle (500mℓ) | ø66 ø2.598 |

Reflector setting range **CX-481**: 300 to 500 mm 11.811 to 19.685 in, **CX-482**: 1 to 2 m 3.281 to 6.562 ft

[with the **RF-230** reflector at the optimum condition (Note)]

Each object should pass across the beam at the center between the sensor and the reflector.

ℓ: Length of cylindrical glasses
t: Thickness of sensing object

Note: The optimum condition is defined as the condition in which the sensitivity level is set such that the stability indicator just lights up when the object is absent.

Long sensing range of 5 m 16.4 ft **CX-493**

A long 5 m 16.4 ft sensing range is possible with the red LED type that is easy to align with the beam axis. Can be used for wide automatic door shutters.



Ultra-long sensing range of 30 m 98.4 ft **CX-413**

The **CX-413** achieves the ultra-long sensing range of 30 m 98.4 ft. It can be used for a stacker crane or a multilevel parking structure.



ENVIRONMENTAL RESISTANCE

Strong on dust and dirt **CX-412/413**

Because the light source is an infrared light, it is strong on dust and dirt compared to the red beam type.

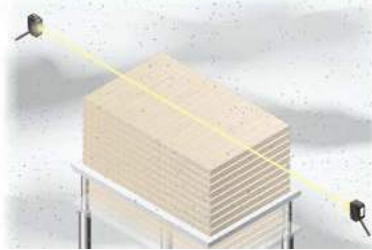

Stronger noise resistance

The **CX-400** series has a higher noise resistance than its previous model. By incorporating an inverter countermeasure circuit that appropriately shifts with peak wavelength, the sensor now resists high-frequency noise from high-voltage inverter motors and inverter lights more effectively.

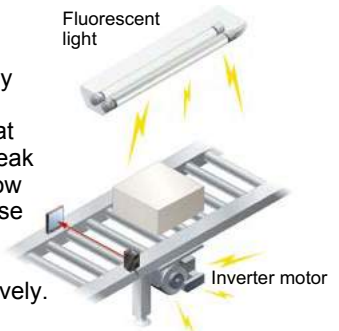

Strong even in cold environments

Stable performance can be maintained even in environments of -25 °C -13 °F.

ECO

Thoroughly eliminating unnecessary waste, Reducing many environmental burdens



The **CX-400** series has three different cable length types and uses very simple packaging to reduce waste. The bag is made of polyethylene and does not emit toxic gasses.



MOUNTING

Beam axis alignment made easy with a high luminance spot beam **CX-423**

These sensors have a high luminance red LED spot beam which provides bright visibility enabling the sensing position to be checked at a glance. Because it achieved small beam spot approx. $\varnothing 2$ mm $\varnothing 0.079$ in at setting distance 100 mm 3.937 in, approx. $\varnothing 5$ mm $\varnothing 0.197$ in at setting distance 200 mm 7.874 in, even the minutest object can be accurately detected.

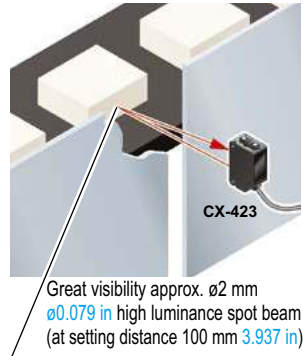

The bright spot makes beam axis alignment easy **CX-441**

These sensors have a high luminance red spot that provides bright visibility. The sensing position can be checked at a glance. Because the **CX-441** sensor has the smallest spot in its class $\varnothing 2$ mm $\varnothing 0.079$ in approx., even the minutest object can be accurately detected.



OPERABILITY

Reduction of volume adjustment labor **CX-423**

Because these sensors possess many variations depending on the sensing range, enables you to make optimal volume adjustment easily.

CX-422: 800 mm 31.496 in
CX-421: 300 mm 11.811 in
CX-424: 100 mm 3.937 in



Can be used for sensing minute differences **CX-441**

Equipped with a 5-turn adjuster so that even challenging range settings can be handled with ease.

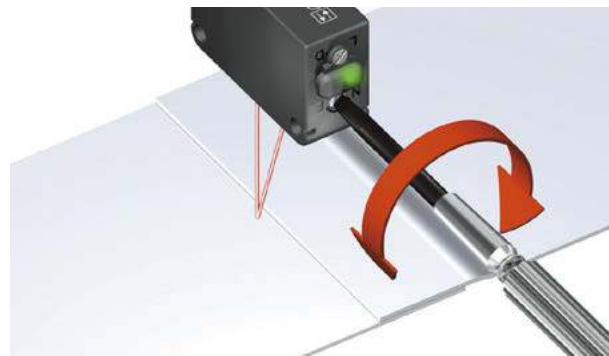

VARIETIES

Basic type available

Omit the sensitivity adjuster and operation mode switch and release a basic type cable 0.5 m 1.641 ft in length. If the usage is clear, quick construction can be performed onsite without detailed adjustments and the cost can be controlled.

Less processing time



M8 plug-in connector type and M12 pigtailed type are available. This contributes to less time spent in setting up. In addition, cable types are available with cable lengths of 0.5 m 1.640 ft, 2 m 6.562 ft and 5 m 16.404 ft. This results in less wastage.

No unnecessary cables or terminal blocks

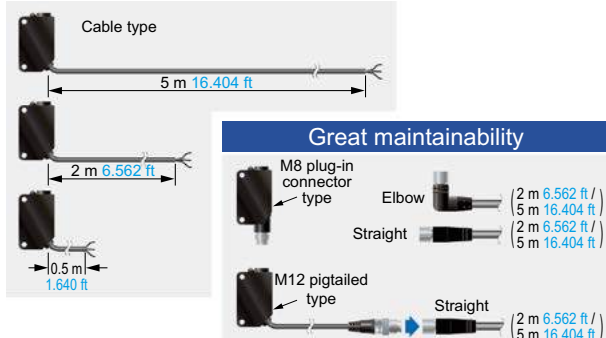

Select from 2 spot diameters as per the application **CX-441/443**

Within the choice of 50 mm 1.969 in sensing range sensors, we offer small spot approx. $\varnothing 2$ mm $\varnothing 0.079$ in type optimal for detecting minute object and large approx. $\varnothing 6.5$ mm $\varnothing 0.256$ in spot type capable of sensing object covered with holes and grooves.

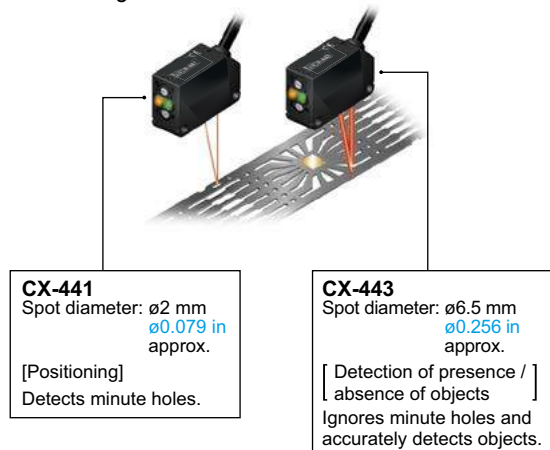

FIBER SENSORS

LASER SENSORS

PHOTOELECTRIC SENSORS

MICRO PHOTOELECTRIC SENSORS

AREA SENSORS

SAFETY LIGHT CURTAINS / SAFETY COMPONENTS

PRESSURE / FLOW SENSORS

INDUCTIVE PROXIMITY SENSORS

PARTICULAR USE SENSORS

SENSOR OPTIONS

SIMPLE WIRE-SAVING UNITS

WIRE-SAVING SYSTEMS

MEASUREMENT SENSORS

STATIC CONTROL DEVICES

LASER MARKERS

PLC

HUMAN MACHINE INTERFACES

ENERGY MANAGEMENT SOLUTIONS

FA COMPONENTS

MACHINE VISION SYSTEMS

UV CURING SYSTEMS

Selection Guide

Amplifier Built-in

Power Supply Built-in

Amplifier-separated

EX-Z

CX-400

CY-100

EX-10

EX-20

EX-30

EX-40

CX-440

EQ-30

EQ-500

MQ-W

RX-LS200

RX

RT-610

- FIBER SENSORS
- LASER SENSORS
- PHOTOELECTRIC SENSORS
- MICRO PHOTOELECTRIC SENSORS
- AREA SENSORS
- SAFETY LIGHT CURTAINS / SAFETY COMPONENTS
- PRESSURE / FLOW SENSORS
- INDUCTIVE PROXIMITY SENSORS
- PARTICULAR USE SENSORS
- SENSOR OPTIONS
- SIMPLE WIRE-SAVING UNITS
- WIRE-SAVING SYSTEMS
- MEASUREMENT SENSORS
- STATIC CONTROL DEVICES
- LASER MARKERS
- PLC
- HUMAN MACHINE INTERFACES
- ENERGY MANAGEMENT SOLUTIONS
- FA COMPONENTS
- MACHINE VISION SYSTEMS
- UV CURING SYSTEMS
- Selection Guide
- Amplifier Built-in
- Power Supply Built-in
- Amplifier-separated
- EX-Z**
- CX-400**
- CY-100
- EX-10
- EX-20
- EX-30
- EX-40
- CX-440
- EQ-30
- EQ-500
- MQ-W
- RX-LS200
- RX
- RT-610

FUNCTIONS

BGS/FGS functions make even the most challenging settings possible!

CX-44□

For details on the operation of the BGS/FGS functions, refer to “**BGS/FGS functions (p.267)**” of “**PRECAUTIONS FOR PROPER USE**”.

The BGS function is best suited for the following case

Background not present

When object and background are separated

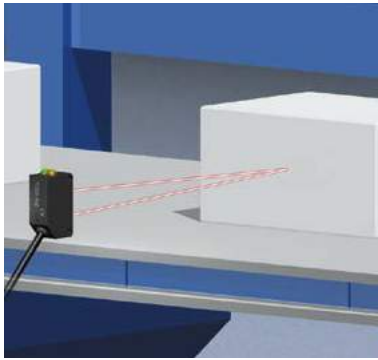

Not affected if the background color changes or someone passes behind the conveyor.

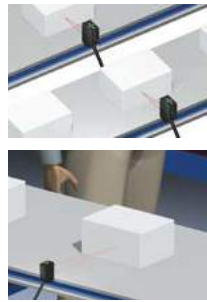

The FGS function is best suited for the following case

Background present

When object and background are close together
When the object is glossy or uneven

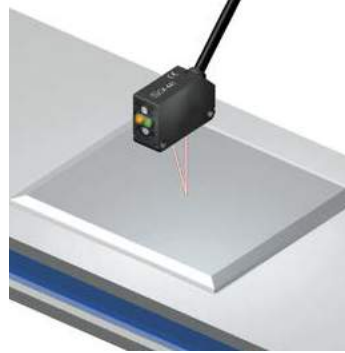

Unaffected by gloss, color or uneven surfaces when sensing objects present on a conveyor belt.

Caution: Please use the FGS function together with a conveyor or other background unit.

BGS (Background suppression) function

The sensor judges that an object is present when light is received at position A of the light-receiving element (2-segment element).

This is useful if the object and background are far apart. The distance adjustment method is the same as the conventional adjustment method for adjustable range reflective type sensors.

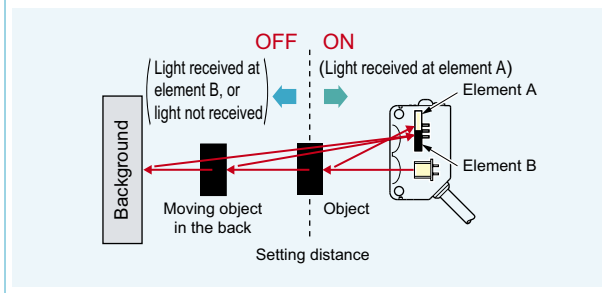

FGS (Foreground suppression) function

The sensor judges that an object is present when no light is received at position B of the light-receiving element (2-segment element). Accordingly, even objects that are glossy can be sensed. This is useful if the object and background are close together, or if the object being sensed is glossy.

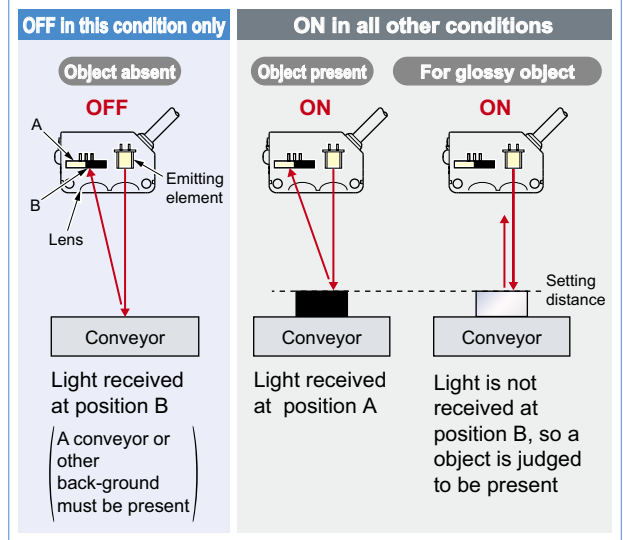

Strong against interference

The interference prevention function lets two sensors to be mounted close together precisely.

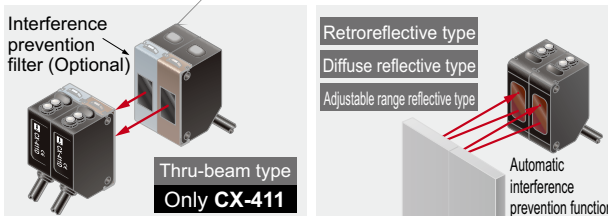

ORDER GUIDE

Standard type

| Type | Appearance | Sensing range | Model No. (Note 1) | | Output operation | Emitting element |
|---|------------|--|--------------------|-----------------|---|------------------|
| | | | NPN output | PNP output | | |
| Thru-beam Long sensing range | | 10 m 32.808 ft | CX-411 | CX-411-P | Switchable either Light-ON or Dark-ON | Red LED |
| | | 15 m 49.213 ft | CX-412 | CX-412-P | | |
| | | 30 m 98.425 ft | CX-413 | CX-413-P | | |
| Retroreflective For transparent object sensing | | 3 m 9.843 ft (Note 2) | CX-491 | CX-491-P | | Infrared LED |
| | | 5 m 16.404 ft (Note 2) | CX-493 | CX-493-P | | |
| | | 50 to 500 mm 1.969 to 19.685 in (Note 2) | CX-481 | CX-481-P | | |
| | | 50 to 1,000mm 1.969 to 39.37 in (Note 2) | CX-483 | CX-483-P | | |
| Diffuse reflective Narrow view | | 100 mm 3.937 in | CX-424 | CX-424-P | Infrared LED | |
| | | 300 mm 11.811 in | CX-421 | CX-421-P | | |
| | | 800 mm 31.496 in | CX-422 | CX-422-P | | |
| | | 70 to 300 mm 2.756 to 11.811 in | CX-423 | CX-423-P | | |
| Adjustable range reflective Small spot | | 2 to 50 mm 0.079 to 1.969 in | CX-441 | CX-441-P | Switchable either Detection-ON or Detection-OFF | Red LED |
| | | 15 to 100 mm 0.591 to 3.937 in | CX-444 | CX-444-P | | |
| | | 20 to 300 mm 0.787 to 11.811 in | CX-442 | CX-442-P | | |

NOTE: Mounting bracket is not supplied with the sensor. Please select from the range of optional sensor mounting brackets.

- Notes: 1) The model No. with "E" shown on the label affixed to the thru-beam type sensor is the emitter, "D" shown on the label is the receiver.
 2) The sensing range of the retroreflective type sensor is specified for the RF-230 (optional) reflector. The sensing range represents the actual sensing range of the sensor. The sensing ranges itemized in "A" of the table below may vary depending on the shape of sensing object. Be sure to check the operation with the actual sensing object.

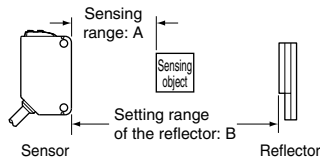

| | CX-491 □ | CX-493 □ | CX-481 □ | CX-483 □ | CX-482 □ |
|---|---------------------------------|----------------------------------|-------------------------------------|--------------------------------------|---------------------------------|
| A | 0 to 3 m 0 to 9.843 ft | 0 to 5 m 0 to 16.404 ft | 50 to 500 mm 1.969 to 19.685 in | 50 to 1,000 mm 1.969 to 39.37 in | 0.1 to 2 m 0.328 to 6.562 ft |
| B | 0.1 to 3 m 0.328 to 9.843 ft | 0.1 to 5 m 0.328 to 16.404 ft | 100 to 500 mm 3.937 to 19.685 in | 100 to 1,000 mm 3.937 to 39.37 in | 0.8 to 2 m 2.625 to 6.562 ft |

FIBER SENSORS

LASER SENSORS

PHOTO-ELECTRIC SENSORS

MICRO PHOTO-ELECTRIC SENSORS

AREA SENSORS

SAFETY LIGHT CURTAINS / SAFETY COMPONENTS

PRESSURE / FLOW SENSORS

INDUCTIVE PROXIMITY SENSORS

PARTICULAR USE SENSORS

SENSOR OPTIONS

SIMPLE WIRE-SAVING UNITS

WIRE-SAVING SYSTEMS

MEASUREMENT SENSORS

STATIC CONTROL DEVICES

LASER MARKERS

PLC

HUMAN MACHINE INTERFACES

ENERGY MANAGEMENT SOLUTIONS

FA COMPONENTS

MACHINE VISION SYSTEMS

UV CURING SYSTEMS

Selection Guide

Amplifier Built-in

Power Supply Built-in

Amplifier-separated

EX-Z

CX-400

CY-100

EX-10

EX-20

EX-30

EX-40

CX-440

EQ-30

EQ-500

MQ-W

RX-LS200

RX

RT-610

ORDER GUIDE

Basic type (Without operation mode switch and sensitivity adjuster. Cable is 0.5 m 1.640 ft long.)

| Type | Appearance | Sensing range | Model No. (Note 1) | | Output operation | Emitting element |
|---|------------|-----------------------|----------------------|------------------------|------------------|------------------|
| | | | NPN output | PNP output | | |
| Thru-beam Long sensing range | | 10 m 32.808 ft | CX-411A-C05 | CX-411A-P-C05 | Light-ON | Red LED |
| | | | CX-411B-C05 | CX-411B-P-C05 | Dark-ON | |
| | | 15 m 49.213 ft | CX-412A-C05 | CX-412A-P-C05 | Light-ON | Infrared LED |
| | | | CX-412B-C05 | CX-412B-P-C05 | Dark-ON | |
| Retroreflective With polarizing filters Optional (Note 2) | | 3 m 9.843 ft (Note 3) | CX-491A-C05-Y | CX-491A-P-C05-Y | Light-ON | Red LED |
| | | | CX-491B-C05-Y | CX-491B-P-C05-Y | Dark-ON | |

NOTE: Mounting bracket is not supplied with the sensor. Please select from the range of optional sensor mounting brackets.

- Notes: 1) The model No. with "E" shown on the label affixed to the thru-beam type sensor is the emitter, "D" shown on the label is the receiver.
 2) The reflector is an option. The sensing range of the reflector is specified for the **RF-230**.
 3) The sensing range of the retroreflective type sensor is specified for the **RF-230** (optional) reflector (p.253). The sensing range represents the actual sensing range of the sensor. The sensing range : A of the table below may vary depending on the shape of sensing object. Be sure to check the operation with the actual sensing object.

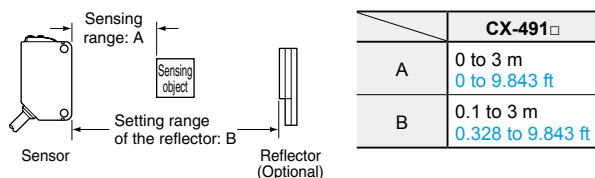

FIBER SENSORS

LASER SENSORS

PHOTO-ELECTRIC SENSORS
MICRO PHOTO-ELECTRIC SENSORS

AREA SENSORS

SAFETY LIGHT CURTAINS / SAFETY COMPONENTS

PRESSURE / FLOW SENSORS

INDUCTIVE PROXIMITY SENSORS

PARTICULAR USE SENSORS

SENSOR OPTIONS

SIMPLE WIRE-SAVING UNITS

WIRE-SAVING SYSTEMS

MEASUREMENT SENSORS

STATIC CONTROL DEVICES

LASER MARKERS

PLC

HUMAN MACHINE INTERFACES

ENERGY MANAGEMENT SOLUTIONS

FA COMPONENTS

MACHINE VISION SYSTEMS

UV CURING SYSTEMS

Selection Guide

Amplifier Built-in

Power Supply Built-in

Amplifier-separated

EX-Z

CX-400

CY-100

EX-10

EX-20

EX-30

EX-40

CX-440

EQ-30

EQ-500

MQ-W

RX-LS200

RX

RT-610

ORDER GUIDE

0.5 m 1.640 ft / 5 m 16.404 ft cable length types

0.5 m 1.640 ft / 5 m 16.404 ft cable length types (standard: 2 m 6.562 ft, basic: 0.5 m 1.640 ft) are also available.
 When ordering this type, suffix "-C05" for the 0.5 m 1.640 ft cable length type, "-C5" for the 5 m 16.404 ft cable length type to the model No.
 (Excluding CX-44□ and basic type)
 (e.g.) 0.5 m 1.640 ft cable length type of CX-411-P is "CX-411-P-C05"
 5 m 16.404 ft cable length type of CX-411-P is "CX-411-P-C5"

M8 plug-in connector type, M12 pigtailed type

M8 plug-in connector type and M12 pigtailed type are also available.
 When ordering this type, suffix "-Z" for the M8 connector type, "-J" for the M12 pigtailed type to the model No.
 (Please note that M12 pigtailed type is not available for CX-44□. Excluding basic type)
 (e.g.) M8 connector type of CX-411-P is "CX-411-P-Z"
 M12 pigtailed type of CX-411-P is "CX-411-P-J"

- Mating cable (2 cables are required for the thru-beam type.)

| Type | | Model No. | Cable length | Description |
|-------------------------------|----------|------------|---------------|-------------------------------------|
| For M8 plug-in connector type | Straight | CN-24A-C2 | 2 m 6.562 ft | Can be used with all models |
| | | CN-24A-C5 | 5 m 16.404 ft | |
| | Elbow | CN-24AL-C2 | 2 m 6.562 ft | |
| | | CN-24AL-C5 | 5 m 16.404 ft | |
| For M12 pigtailed type | 2-core | CN-22-C2 | 2 m 6.562 ft | For thru-beam type emitter (2-core) |
| | | CN-22-C5 | 5 m 16.404 ft | |
| | 4-core | CN-24-C2 | 2 m 6.562 ft | Can be used with all models |
| | | CN-24-C5 | 5 m 16.404 ft | |

Package without reflector

NPN output type: CX-491-Y
 PNP output type: CX-491-P-Y

Accessory

- RF-230 (Reflector)



Mating cable

- CN-24A-C2
CN-24A-C5
- CN-24AL-C2
CN-24AL-C5

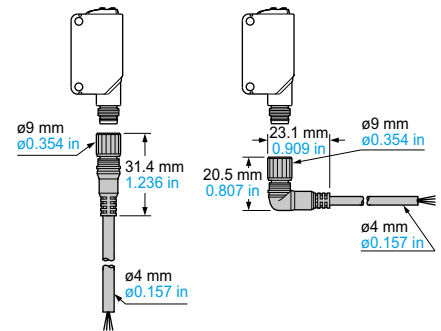

- CN-22-C2, CN-22-C5
CN-24-C2, CN-24-C5

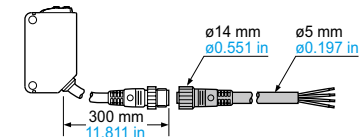

FIBER SENSORS

LASER SENSORS

PHOTO-ELECTRIC SENSORS

MICRO PHOTO-ELECTRIC SENSORS

AREA SENSORS

SAFETY LIGHT CURTAINS / SAFETY COMPONENTS

PRESSURE / FLOW SENSORS

INDUCTIVE PROXIMITY SENSORS

PARTICULAR USE SENSORS

SENSOR OPTIONS

SIMPLE WIRE-SAVING UNITS

WIRE-SAVING SYSTEMS

MEASUREMENT SENSORS

STATIC CONTROL DEVICES

LASER MARKERS

PLC

HUMAN MACHINE INTERFACES

ENERGY MANAGEMENT SOLUTIONS

FA COMPONENTS

MACHINE VISION SYSTEMS

UV CURING SYSTEMS

Selection Guide

Amplifier Built-in

Power Supply Built-in

Amplifier-separated

EX-Z

CX-400

CY-100

EX-10

EX-20

EX-30

EX-40

CX-440

EQ-30

EQ-500

MQ-W

RX-LS200

RX

RT-610

OPTIONS

FIBER SENSORS

LASER SENSORS

PHOTO-ELECTRIC SENSORS

MICRO PHOTO-ELECTRIC SENSORS

AREA SENSORS

SAFETY LIGHT CURTAINS / SAFETY COMPONENTS

PRESSURE / FLOW SENSORS

INDUCTIVE PROXIMITY SENSORS

PARTICULAR USE SENSORS

SENSOR OPTIONS

SIMPLE WIRE-SAVING UNITS

WIRE-SAVING SYSTEMS

MEASUREMENT SENSORS

STATIC CONTROL DEVICES

LASER MARKERS

PLC

HUMAN MACHINE INTERFACES

ENERGY MANAGEMENT SOLUTIONS

FA COMPONENTS

MACHINE VISION SYSTEMS

UV CURING SYSTEMS

Selection Guide

Amplifier Built-in

Power Supply Built-in

Amplifier-separated

EX-Z

CX-400

CY-100

EX-10

EX-20

EX-30

EX-40

CX-440

EQ-30

EQ-500

MQ-W

RX-LS200

RX

RT-610

| Designation | Model No. | | Slit size | Sensing range | | Min. sensing object | |
|---|------------|---------|--------------------------------|--------------------|--------------------|---------------------|--------------------------------|
| | Slit mask | Sensor | | Slit on one side | Slit on both sides | Slit on one side | Slit on both sides |
| Round slit mask (For thru-beam type sensor only) | OS-CX-05 | CX-411□ | ø0.5 mm ø0.020 in | 400 mm 15.748 in | 20 mm 0.787 in | ø12 mm ø0.472 in | ø0.5 mm ø0.020 in |
| | | CX-412□ | | 600 mm 23.622 in | 30 mm 1.181 in | | |
| | | CX-413□ | | 1,200 mm 47.242 in | 60 mm 2.362 in | | |
| | OS-CX-1 | CX-411□ | ø1 mm ø0.039 in | 900 mm 35.433 in | 100 mm 3.937 in | ø12 mm ø0.472 in | ø1 mm ø0.039 in |
| | | CX-412□ | | 1.35 m 4.429 ft | 150 mm 5.906 in | | |
| | | CX-413□ | | 2.7 m 8.857 ft | 300 mm 11.811 in | | |
| | OS-CX-2 | CX-411□ | ø2 mm ø0.079 in | 2 m 6.562 ft | 400 mm 15.748 in | ø12 mm ø0.472 in | ø2 mm ø0.079 in |
| | | CX-412□ | | 3 m 9.843 ft | 600 mm 23.622 in | | |
| | | CX-413□ | | 6 m 19.685 ft | 1,200 mm 47.242 in | | |
| Rectangular slit mask (For thru-beam type sensor only) | OS-CX-05×6 | CX-411□ | 0.5 × 6 mm 0.020 × 0.236 in | 2 m 6.562 ft | 400 mm 15.748 in | ø12 mm ø0.472 in | 0.5 × 6 mm 0.020 × 0.236 in |
| | | CX-412□ | | 3 m 9.843 ft | 600 mm 23.622 in | | |
| | | CX-413□ | | 6 m 19.685 ft | 1,200 mm 47.242 in | | |
| | OS-CX-1×6 | CX-411□ | 1 × 6 mm 0.039 × 0.236 in | 3 m 9.843 ft | 1 m 3.281 ft | ø12 mm ø0.472 in | 1 × 6 mm 0.039 × 0.236 in |
| | | CX-412□ | | 4.5 m 14.764 ft | 1.5 m 4.921 ft | | |
| | | CX-413□ | | 9 m 29.528 ft | 3 m 9.843 ft | | |
| | OS-CX-2×6 | CX-411□ | 2 × 6 mm 0.079 × 0.236 in | 5 m 16.404 ft | 2 m 6.562 ft | ø12 mm ø0.472 in | 2 × 6 mm 0.079 × 0.236 in |
| | | CX-412□ | | 7.5 m 24.606 ft | 3 m 9.843 ft | | |
| | | CX-413□ | | 15 m 49.213 ft | 6 m 19.685 ft | | |

| Designation | Model No. | Sensing range | Min. sensing object |
|--|--|------------------------|--|
| Interference prevention filter (For CX-411□ only) | PF-CX4-V (Vertical, Silver) 2 pcs. per set | 5 m 16.404 ft (Note 1) | ø12 mm ø0.472 in (Note 1) |
| | PF-CX4-H (Horizontal, Light brown) 2 pcs. per set | | |
| Reflector (For retro-reflective type sensor only) | RF-210 | CX-491□ | 1 m 3.281 ft (Note 2) |
| | | CX-493□ | 1.5 m 4.921 ft (Note 2) |
| | | CX-481□ | — |
| | | CX-483□ | 0.1 to 0.3 m 0.328 to 0.984 ft (Note 2) |
| | RF-220 | CX-482□ | 0.1 to 0.6 m 0.328 to 1.969 ft (Note 2) |
| | | CX-491□ | 1.5 m 4.921 ft (Note 2) |
| | | CX-493□ | 3 m 9.843 ft (Note 2) |
| | | CX-481□ | 50 to 300 mm 1.969 to 11.811 in (Note 2) |
| | | CX-483□ | 0.1 to 0.7 m 0.328 to 2.297 ft (Note 2) |
| | | CX-482□ | 0.1 to 1.3 m 0.328 to 4.265 ft (Note 2) |
| RF-230 (Note 3) | CX-491□-Y□ | 3 m 9.843 ft (Note 2) | ø50 mm ø1.969 in |

Notes: 1) Value when attached on both sides.
 2) Set the distance between the CX-491□/493□ and the reflector to 0.1 m 0.328 ft or more. However, see the table below for CX-48□.
 The sensing range "A" may vary depending on the shape of sensing object. Be sure to check the operation with the actual sensing object.

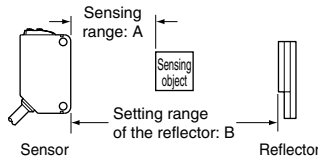

| Model No. | A | | B | |
|-----------|--------|---------------------------------|----------------------------------|---|
| | Sensor | Reflector | A | B |
| CX-481□ | RF-220 | 50 to 300 mm 1.969 to 11.811 in | 100 to 300 mm 3.937 to 11.811 in | |
| | RF-220 | 0.1 to 0.7 m 0.328 to 2.297 ft | 0.2 to 0.7 m 0.656 to 2.297 ft | |
| CX-483□ | RF-210 | 0.1 to 0.3 m 0.328 to 0.984 ft | 0.1 to 0.3 m 0.328 to 0.984 ft | |
| | RF-230 | 0.05 to 1 m 0.164 to 3.281 ft | 0.1 to 1 m 0.328 to 3.281 ft | |
| CX-482□ | RF-220 | 0.1 to 1.3 m 0.328 to 4.265 ft | 0.5 to 1.3 m 1.640 to 4.265 ft | |
| | RF-210 | 0.1 to 0.6 m 0.328 to 1.969 ft | 0.3 to 0.6 m 0.984 to 1.969 ft | |

3) RF-230 is attached to the retroreflective type sensor other than the basic type.

Round slit mask

• OS-CX-□
Fitted on the front face of the sensor with one-touch.

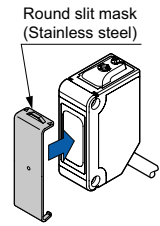

Rectangular slit mask

• OS-CX-□×6
Fitted on the front face of the sensor with one-touch.

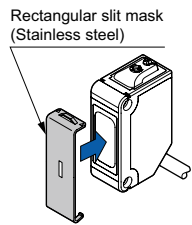

Interference prevention filter

• PF-CX4-V
(Vertical, Silver)
• PF-CX4-H
(Horizontal, Light brown)
Two sets of CX-411□ can be mounted close together.

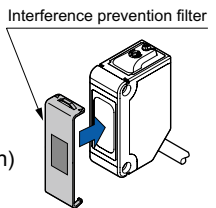

Reflector

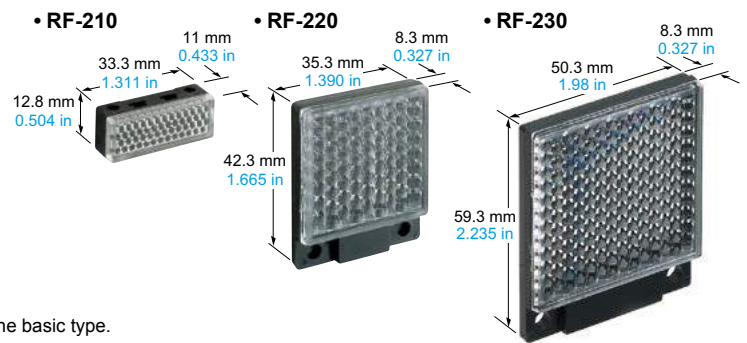

OPTIONS

| Designation | Model No. | Description |
|--|------------------|--|
| Reflector mounting bracket | MS-RF21-1 | Protective mounting bracket for RF-210 It protects the reflector from damage and maintains alignment. |
| | MS-RF22 | For RF-220 |
| | MS-RF23 | For RF-230 |
| Reflective tape | RF-11 | <ul style="list-style-type: none"> Sensing range (Note 4): 0.5 m 1.640 ft [CX-491] 0.8 m 2.625 ft [CX-493] Ambient temperature: -25 to $+50$ °C -13 to $+122$ °F Ambient humidity: 35 to 85 % RH Notes: 1) Keep the tape free from stress. If it is pressed too much, its capability may deteriorate. 2) Do not cut the tape. It will deteriorate the sensing performance. |
| | RF-12 | <ul style="list-style-type: none"> Sensing range (Note 4): 0.7 m 2.297 ft [CX-491] 1.2 m 3.937 ft [CX-493] 0.1 to 0.6 m 0.328 to 1.969 ft [CX-482] |
| | RF-13 | <ul style="list-style-type: none"> Sensing range (Note 5): 0.5 m 1.640 ft [CX-491] Ambient temperature: -25 to $+55$ °C -13 to $+131$ °F Ambient humidity: 35 to 85 % RH |
| Sensor mounting bracket (Note 1) | MS-CX2-1 | Foot angled mounting bracket It can also be used for mounting RF-210 . |
| | MS-CX2-2 | Foot biangled mounting bracket It can also be used for mounting RF-210 . |
| | MS-CX2-4 | Protective mounting bracket |
| | MS-CX2-5 | Back biangled mounting bracket |
| | MS-CX-3 | Back angled mounting bracket |
| Universal sensor mounting stand (Note 2) | MS-AJ1 | Horizontal mounting type |
| | MS-AJ2 | Vertical mounting type |
| | MS-AJ1-A | Horizontal mounting type |
| | MS-AJ2-A | Vertical mounting type |
| | MS-AJ1-M | Horizontal mounting type |
| Sensor checker (Note 3) | CHX-SC2 | It is useful for beam alignment of thru-beam type sensors. The optimum receiver position is given by indicators, as well as an audio signal. |

- Notes: 1) The plug-in connector type sensor does not allow use of some sensor mounting brackets because of the protrusion of the connector.
 2) Refer to p.953~ for the universal sensor mounting stand **MS-AJ** series.
 3) Refer to p.959~ for the sensor checker **CHX-SC2**.
 4) Set the distance between the sensor and the reflective tape to 0.1 m **0.328 ft (CX-482)**, 0.4 m **1.312 ft** or more.
 5) Set the distance between the sensor and the reflective tape to 0.2 m **0.656 ft** or more.

Universal sensor mounting stand

• MS-AJ1

Swivel: 360° rotation
Height adjustment: 150 mm **5.906 in** approx.
Elevation angle: $\pm 45^\circ$
Mounting hole for M6 screw

• MS-AJ1-A

With the lateral arm, the sensor can sense from above a production line.
Forward / back adjustment: 130 mm **5.118 in** approx.
Swivel: 360° rotation
Height adjustment: 150 mm **5.906 in** approx.
Angle adjustment: $\pm 45^\circ$
Mounting hole for M6 screw

• MS-AJ1-M

Swivel: 360° rotation
Height adjustment: 150 mm **5.906 in** approx.
Elevation angle: $\pm 45^\circ$
Mounting hole for M6 screw

• MS-AJ2

Swivel: 360° rotation
Height adjustment: 150 mm **5.906 in** approx.
Elevation angle: $\pm 45^\circ$
Mounting hole for M6 screw

• MS-AJ2-A

With the lateral arm, the sensor can sense from above a production line.
Forward / back adjustment: 130 mm **5.118 in** approx.
Swivel: 360° rotation
Height adjustment: 150 mm **5.906 in** approx.
Angle adjustment: $\pm 45^\circ$
Mounting hole for M6 screw

• MS-AJ2-M

Swivel: 360° rotation
Height adjustment: 150 mm **5.906 in** approx.
Elevation angle: $\pm 45^\circ$
Mounting hole for M6 screw

Reflector mounting bracket

• MS-RF21-1

Two M3 (length 12 mm **0.472 in**) screws with washers are attached.

• MS-RF22

Two M3 (length 8 mm **0.315 in**) screws with washers are attached.

• MS-RF23

Two M4 (length 10 mm **0.394 in**) screws with washers are attached.

Reflective tape

• RF-11

30 mm **1.181 in**
8 mm **0.315 in**
0.7 mm **0.028 in**

• RF-12

30 mm **1.181 in**
25 mm **0.984 in**
0.7 mm **0.028 in**

• RF-13

30 mm **1.181 in**
30 mm **1.181 in**
0.5 mm **0.020 in**

Sensor mounting bracket

• MS-CX2-1

Two M3 (length 12 mm **0.472 in**) screws with washers are attached.

• MS-CX2-2

Two M3 (length 12 mm **0.472 in**) screws with washers are attached.

• MS-CX2-4

Two M3 (length 14 mm **0.551 in**) screws with washers are attached.

• MS-CX2-5

Two M3 (length 12 mm **0.472 in**) screws with washers are attached.

• MS-CX-3

Two M3 (length 12 mm **0.472 in**) screws with washers are attached.

Sensor checker

• CHX-SC2

Sensor checker

FIBER SENSORS

LASER SENSORS

PHOTO-ELECTRIC SENSORS

MICRO PHOTO-ELECTRIC SENSORS

AREA SENSORS

SAFETY LIGHT CURTAINS / SAFETY COMPONENTS

PRESSURE / FLOW SENSORS

INDUCTIVE PROXIMITY SENSORS

PARTICULAR USE SENSORS

SENSOR OPTIONS

SIMPLE WIRE-SAVING UNITS

WIRE-SAVING SYSTEMS

MEASUREMENT SENSORS

STATIC CONTROL DEVICES

LASER MARKERS

PLC

HUMAN MACHINE INTERFACES

ENERGY MANAGEMENT SOLUTIONS

FA COMPONENTS

MACHINE VISION SYSTEMS

UV CURING SYSTEMS

Selection Guide

Amplifier Built-in

Power Supply Built-in

Amplifier-separated

EX-Z

CX-400

CY-100

EX-10

EX-20

EX-30

EX-40

CX-440

EQ-30

EQ-500

MQ-W

RX-LS200

RX

RT-610

SPECIFICATIONS

Standard type

| Type | Thru-beam | | | Retroreflective | | | | | | Diffuse reflective | | | |
|---|--|--|---|---|---|---|--|---|--|--|------------------------------|------------------------------|--|
| | Long sensing range | | | With polarizing filters | Long sensing range | | For transparent object sensing | | | | | | Narrow-view |
| Model No. | NPN output | CX-411 | CX-412 | CX-413 | CX-491 | CX-493 | CX-481 | CX-483 | CX-482 | CX-424 | CX-421-P | CX-422 | CX-423 |
| Item | PNP output | CX-411-P | CX-412-P | CX-413-P | CX-491-P | CX-493-P | CX-481-P | CX-483-P | CX-482-P | CX-424-P | CX-421-P | CX-422-P | CX-423-P |
| CE marking directive compliance | | | | | | | | | | | | | |
| EMC Directive, RoHS Directive | | | | | | | | | | | | | |
| Sensing range | | 10 m 32.808 ft | 15 m 49.213 ft | 30 m 98.425 ft | 3 m 9.843 ft (Note 2) | 5 m 16.404 ft (Note 2) | 50 to 500 mm 1.969 to 19.685 in (Note 2) | 50 to 1,000 mm 1.969 to 39.37 in (Note 2) | 0.1 to 2 m 0.328 to 6.562 ft (Note 2) | 100 mm 3.937 in (Note 3) | 300 mm 11.811 in (Note 3) | 800 mm 31.496 in (Note 3) | 70 to 300 mm 2.796 to 11.811 in (Note 3) |
| Sensing object | | ø12 mm ø0.472 in or more opaque object (Note 4) | | | ø30 mm ø1.969 in or more opaque, translucent or specular object (Note 2, 5) | ø50 mm ø1.969 in or more opaque or translucent object (Note 2, 5) | ø50 mm ø1.969 in or more transparent, translucent or opaque object (Note 2, 5) | | | Opaque, translucent or transparent object (Note 5) | | | Opaque, translucent or transparent object (Note 5) (Min. sensing object: ø0.5 mm ø0.020 in copper wire) |
| Hysteresis | | 15 % or less of operation distance (Note 3) | | | | | | | | | | | |
| Repeatability (perpendicular to sensing axis) | | 0.5 mm 0.020 in or less | | | | | | | | 1 mm 0.039 in or less | | 0.5 mm 0.020 in or less | |
| Supply voltage | | 12 to 24 V DC ±10 % Ripple P-P 10 % or less | | | | | | | | | | | |
| Current consumption | | Emitter: 15 mA or less Receiver: 10 mA or less | Emitter: 20 mA or less Receiver: 10 mA or less | Emitter: 25 mA or less Receiver: 10 mA or less | 13 mA or less | 10 mA or less | | | | 13 mA or less | | 15 mA or less | |
| Output | | <NPN output type> NPN open-collector transistor • Maximum sink current: 100 mA • Applied voltage: 30 V DC or less (between output and 0 V) • Residual voltage: 2 V or less (at 100 mA sink current) 1 V or less (at 16 mA sink current) | | | | | | <PNP output type> PNP open-collector transistor • Maximum source current: 100 mA • Applied voltage: 30 V DC or less (between output and +V) • Residual voltage: 2 V or less (at 100 mA source current) 1 V or less (at 16 mA source current) | | | | | |
| | Output operation | Switchable either Light-ON or Dark-ON | | | | | | | | | | | |
| | Short-circuit protection | Incorporated | | | | | | | | | | | |
| Response time | | 1 ms or less | 2 ms or less | 1 ms or less | | | | | | | | | |
| Operation indicator | | Orange LED (lights up when the output is ON)(incorporated on the receiver for thru-beam type) | | | | | | | | | | | |
| Stability indicator | | Green LED (lights up under stable light received condition or stable dark condition)(incorporated on the receiver for thru-beam type) | | | | | | | | | | | |
| Power indicator | | Green LED (lights up when the power is ON) (incorporated on the emitter) | | | | | | | | | | | |
| Sensitivity adjuster | | Continuously variable adjuster (incorporated on the receiver for thru-beam type) | | | | | | | | | | | |
| Automatic interference prevention function | | Two units of sensors can be mounted close together with interference prevention filters. (Sensing range: 5 m 16.404 ft) | | | Incorporated (Two units of sensors can be mounted close together.) | | | | | | | | |
| Environmental resistance | Protection | IP67 (IEC) | | | | | | | | | | | |
| | Ambient temperature | -25 to +55 °C -13 to +131 °F (No dew condensation or icing allowed), Storage: -30 to +70 °C -22 to +158 °F | | | | | | | | | | | |
| | Ambient humidity | 35 to 85 % RH, Storage: 35 to 85 % RH | | | | | | | | | | | |
| | Ambient illuminance | Incandescent light: 3,000 lx or less at the light-receiving face | | | | | | | | | | | |
| | Voltage withstandability | 1,000 V AC for one min. between all supply terminals connected together and enclosure | | | | | | | | | | | |
| | Insulation resistance | 20 MΩ, or more, with 250 V DC megger between all supply terminals connected together and enclosure | | | | | | | | | | | |
| | Vibration resistance | 10 to 500 Hz frequency, 1.5 mm 0.059 in double amplitude (10 G max.) in X, Y and Z directions for two hours each | | | | | | | | | | | |
| | Shock resistance | 500 m/s ² acceleration (50 G approx.) in X, Y and Z directions three times each | | | | | | | | | | | |
| Emitting element (modulated) | | Red LED | Infrared LED | | Red LED | Infrared LED | | Infrared LED | | Infrared LED | | Red LED | |
| | Peak emission wavelength | 680 nm 0.027 mil | 870 nm 0.034 mil | 850 nm 0.033 mil | 680 nm 0.027 mil | 650 nm 0.026 mil | 870 nm 0.034 mil | | 860 nm 0.033 mil | | 645 nm 0.025 mil | | |
| Material | Enclosure: PBT (Polybutylene terephthalate), Lens: Acrylic (CX-48□: Polycarbonate), Indicator cover: Acrylic (CX-48□: Polycarbonate) | | | | | | | | | | | | |
| Cable | 0.2 mm ² 3-core (thru-beam type emitter: 2-core) cabtyre cable, 2 m 6.562 ft long | | | | | | | | | | | | |
| Cable extension | Extension up to total 100 m 328.084 ft is possible with 0.3 mm ² , or more, cable (thru-beam type: both emitter and receiver) | | | | | | | | | | | | |
| Weight | Net | Emitter: 45 g approx., Receiver: 50 g approx. | | | | 50 g approx. | | | | 60 g approx. | | | |
| | Gross | 100 g approx. | | | | 80 g approx. | | | | 60 g approx. | | | |
| Accessories | RF-230 (Reflector): 1 pc. | | | | | | | | | | | | |

Notes: 1) Where measurement conditions have not been specified precisely, the conditions used were an ambient temperature of +23 °C +73.4 °F.
 2) The sensing range and the sensing object of the retroreflective type sensor are specified for the RF-230 reflector. The sensing range represents the actual sensing range of the sensor. The sensing range : A of the table below may vary depending on the shape of sensing object. Be sure to check the operation with the actual sensing object.

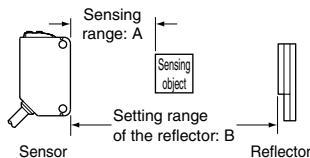

| | CX-491□ | CX-493□ | CX-481□ | CX-483□ | CX-482□ |
|---|---------------------------------|----------------------------------|-------------------------------------|--------------------------------------|---------------------------------|
| A | 0 to 3 m 0 to 9.843 ft | 0 to 5 m 0 to 16.404 ft | 50 to 500 mm 1.969 to 19.685 in | 50 to 1,000 mm 1.969 to 39.37 in | 0.1 to 2 m 0.328 to 6.562 ft |
| B | 0.1 to 3 m 0.328 to 9.843 ft | 0.1 to 5 m 0.328 to 16.404 ft | 100 to 500 mm 3.937 to 19.685 in | 100 to 1,000 mm 3.937 to 39.37 in | 0.8 to 2 m 2.625 to 6.562 ft |

3) The sensing range and hysteresis of the diffuse reflective type sensor are specified for white non-glossy paper (200 × 200 mm 7.874 × 7.874 in) as the object.
 4) If slit masks (optional) are fitted, an object of ø0.5 mm ø0.020 in (using round slit mask) can be detected.
 5) Make sure to confirm detection with an actual sensor before use.

SPECIFICATIONS

Standard type

| Item | Model No. | Type | Adjustable range reflective | | | |
|---|--------------------------|---|--|--|--|----------|
| | | NPN output | CX-441 | CX-443 | CX-444 | CX-442 |
| | | PNP output | CX-441-P | CX-443-P | CX-444-P | CX-442-P |
| CE marking directive compliance | | EMC Directive, RoHS Directive | | | | |
| Adjustable range (Note 2) | | 20 to 50 mm 0.787 to 1.969 in | | 20 to 100 mm 0.787 to 3.937 in | 40 to 300 mm 1.575 to 11.811 in | |
| Sensing range (with white non-glossy paper) | | 2 to 50 mm 0.079 to 1.969 in | | 15 to 100 mm 0.591 to 3.937 in | 20 to 300 mm 0.787 to 11.811 in | |
| Hysteresis (with white non-glossy paper) | | 2 % or less of operation distance | | | 5 % or less of operation distance | |
| Repeatability | | Along sensing axis: 1 mm 0.039 in or less, Perpendicular to sensing axis: 0.2 mm 0.008 in or less (with white non-glossy paper) | | | | |
| Supply voltage | | 12 to 24 V DC ±10 % Ripple P-P 10 % or less | | | | |
| Current consumption | | 20 mA or less | | | | |
| Output | | <NPN output type> NPN open-collector transistor | | <PNP output type> PNP open-collector transistor | | |
| | | <ul style="list-style-type: none"> Maximum sink current: 100 mA Applied voltage: 30 V DC or less (between output and 0 V) Residual voltage: 2 V or less (at 100 mA sink current) | | <ul style="list-style-type: none"> Maximum source current: 100 mA Applied voltage: 30 V DC or less (between output and +V) Residual voltage: 2 V or less (at 100 mA source current) | | |
| | | 1 V or less (at 16 mA sink current) | | 1 V or less (at 16 mA source current) | | |
| Output operation | | Switchable either Detection-ON or Detection-OFF | | | | |
| Short-circuit protection | | Incorporated | | | | |
| Response time | | 1 ms or less | | | | |
| Operation indicator | | Orange LED (lights up when the output is ON) | | | | |
| Stability indicator | | Green LED (lights up under stable operating condition) (Note 3) | | | | |
| Distance adjuster | | 5-turn mechanical adjuster | | | | |
| Sensing mode | | BGS/FGS functions Switchable with wiring of sensing mode selection input | | | | |
| Automatic interference prevention function (Note 4) | | Incorporated | | | | |
| Environmental resistance | Protection | | IP67 (IEC) | | | |
| | Ambient temperature | | -25 to +55 °C -13 to +131 °F (No dew condensation or icing allowed), Storage: -30 to +70 °C -22 to +158 °F | | | |
| | Ambient humidity | | 35 to 85 % RH, Storage: 35 to 85 % RH | | | |
| | Ambient illuminance | | Incandescent light: 3,000 lx or less at the light-receiving face | | | |
| | Voltage withstandability | | 1,000 V AC for one min. between all supply terminals connected together and enclosure | | | |
| | Insulation resistance | | 20 MΩ, or more, with 250 V DC megger between all supply terminals connected together and enclosure | | | |
| | Vibration resistance | | 10 to 500 Hz frequency, 3 mm 0.118 in double amplitude (20 G max) in X, Y and Z directions for two hours each | | | |
| Shock resistance | | 500 m/s ² acceleration (50 G approx.) in X, Y and Z directions three times each | | | | |
| Emitting element | | Red LED (Peak emission wavelength: 650 nm 0.026 mil , modulated) | | | | |
| Spot diameter | | ø2 mm ø0.079 in approx. (at 50 mm 1.969 in distance) | ø6.5 mm ø0.256 in approx. (at 50 mm 1.969 in distance) | ø9 mm ø0.354 in approx. (at 100 mm 3.937 in distance) | ø15 mm ø0.591 in approx. (at 300 mm 11.811 in distance) | |
| Material | | Enclosure: PBT (Polybutylene terephthalate), Lens: Polycarbonate, Indicator cover: Polycarbonate | | | | |
| Cable | | 0.2 mm ² 4-core cabtyre cable, 2 m 6.562 ft long | | | | |
| Cable extension | | Extension up to total 100 m 328.084 ft is possible with 0.3 mm ² , or more, cable. | | | | |
| Weight | | Net weight: 55 g approx., Gross weight: 65 g approx. | | | | |

Notes: 1) Where measurement conditions have not been specified precisely, the conditions used were an ambient temperature of +23 °C **+73.4 °F**.
 2) The adjustable range stands for the maximum sensing range which can be set with the distance adjuster. The sensor can detect an object 2 mm **0.079 in** [CX-444(-P)]: 15 mm **0.591 in**, CX-442(-P): 20 mm **0.787 in**], or more, away.

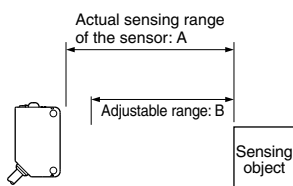

| | CX-441□/443□ | CX-444□ | CX-442□ |
|---|---|--|---|
| A | 2 to 50 mm 0.079 to 1.969 in | 15 to 100 mm 0.591 to 3.937 in | 20 to 300 mm 0.787 to 11.811 in |
| B | 20 to 50 mm 0.787 to 1.969 in | 20 to 100 mm 0.787 to 3.937 in | 40 to 300 mm 1.575 to 11.811 in |

3) Refer to "Stability indicator (p.267)" of "PRECAUTIONS FOR PROPER USE" for operation of the stability indicator.
 4) Note that detection may be unstable depending on the mounting conditions or the sensing object. In the state that this product is mounted, be sure to check the operation with the actual sensing object.

FIBER SENSORS
 LASER SENSORS
 PHOTO-ELECTRIC SENSORS
 MICRO PHOTO-ELECTRIC SENSORS
 AREA SENSORS
 SAFETY LIGHT CURTAINS / SAFETY COMPONENTS
 PRESSURE / FLOW SENSORS
 INDUCTIVE PROXIMITY SENSORS
 PARTICULAR USE SENSORS
 SENSOR OPTIONS
 SIMPLE WIRE-SAVING UNITS
 WIRE-SAVING SYSTEMS
 MEASUREMENT SENSORS
 STATIC CONTROL DEVICES
 LASER MARKERS
 PLC
 HUMAN MACHINE INTERFACES
 ENERGY MANAGEMENT SOLUTIONS
 FA COMPONENTS
 MACHINE VISION SYSTEMS
 UV CURING SYSTEMS
 Selection Guide
 Amplifier Built-in
 Power Supply Built-in
 Amplifier-separated
EX-Z
CX-400
CY-100
EX-10
EX-20
EX-30
EX-40
CX-440
EQ-30
EQ-500
MQ-W
RX-LS200
RX
RT-610

FIBER SENSORS
LASER SENSORS
PHOTO-ELECTRIC SENSORS
MICRO PHOTO-ELECTRIC SENSORS
AREA SENSORS
SAFETY LIGHT CURTAINS / SAFETY COMPONENTS
PRESSURE / FLOW SENSORS
INDUCTIVE PROXIMITY SENSORS
PARTICULAR USE SENSORS
SENSOR OPTIONS
SIMPLE WIRE-SAVING UNITS
WIRE-SAVING SYSTEMS
MEASUREMENT SENSORS
STATIC CONTROL DEVICES
LASER MARKERS
PLC
HUMAN MACHINE INTERFACES
ENERGY MANAGEMENT SOLUTIONS
FA COMPONENTS
MACHINE VISION SYSTEMS
UV CURING SYSTEMS
Selection Guide
Amplifier Built-in
Power Supply Built-in
Amplifier-separated
EX-Z
CX-400
CY-100
EX-10
EX-20
EX-30
EX-40
CX-440
EQ-30
EQ-500
MQ-W
RX-LS200
RX
RT-610

SPECIFICATIONS

Basic type

| Type | Thru-beam | | | | Retroreflective | | | |
|---|--------------------------|--|---------------|---|-------------------------|---|-----------------|-----------------|
| | Long sensing range | | | | With polarizing filters | | | |
| | Light-ON | Dark-ON | Light-ON | Dark-ON | Light-ON | Dark-ON | | |
| Item | Model No. | NPN output | CX-411A-C05 | CX-411B-C05 | CX-412A-C05 | CX-412B-C05 | CX-491A-C05-Y | CX-491B-C05-Y |
| | | PNP output | CX-411A-P-C05 | CX-411B-P-C05 | CX-412A-P-C05 | CX-412B-P-C05 | CX-491A-P-C05-Y | CX-491B-P-C05-Y |
| CE marking directive compliance | | EMC Directive, RoHS Directive | | | | | | |
| Sensing range | | 10 m 32.808 ft | | 15 m 49.213 ft | | 3 m 9.843 ft (Note 2) | | |
| Sensing object | | ø12 mm ø0.472 in or more opaque object (Note 3) | | | | ø50 mm ø1.969 in or more transparent, translucent or opaque object (Note 2, 4) | | |
| Hysteresis | | — | | | | | | |
| Repeatability (perpendicular to sensing axis) | | 0.5 mm 0.020 in or less | | | | | | |
| Supply voltage | | 12 to 24 V DC ±10 % Ripple P-P 10 % or less | | | | | | |
| Current consumption | | Emitter: 15 mA or less Receiver: 10 mA or less | | Emitter: 20 mA or less Receiver: 10 mA or less | | 13 mA or less | | |
| Output | | <NPN output type> NPN open-collector transistor • Maximum sink current: 100 mA • Applied voltage: 30 V DC or less (between output and 0 V) • Residual voltage: 2 V or less (at 100 mA sink current) 1 V or less (at 16 mA sink current) | | | | <PNP output type> PNP open-collector transistor • Maximum source current: 100 mA • Applied voltage: 30 V DC or less (between output and +V) • Residual voltage: 2 V or less (at 100 mA source current) 1 V or less (at 16 mA source current) | | |
| Short-circuit protection | | Incorporated | | | | | | |
| Response time | | 1 ms or less | | | | | | |
| Operation indicator | | Orange LED (lights up when the output is ON)(incorporated on the receiver for thru-beam type) | | | | | | |
| Stability indicator | | Green LED (lights up under stable light received condition or stable dark condition)(incorporated on the receiver for thru-beam type) | | | | | | |
| Power indicator | | Green LED (lights up when the power is ON) (incorporated on the emitter) | | | | — | | |
| Sensitivity adjuster | | — | | | | | | |
| Automatic interference prevention function | | [Two units of sensors can be mounted close together with interference prevention filters. (Sensing range: 5 m 16.404 ft)] | | — | | Incorporated (Two units of sensors can be mounted close together.) | | |
| Environmental resistance | Protection | IP67 (IEC) | | | | | | |
| | Ambient temperature | -25 to +55 °C -13 to +131 °F (No dew condensation or icing allowed), Storage: -30 to +70 °C -22 to +158 °F | | | | | | |
| | Ambient humidity | 35 to 85 % RH, Storage: 35 to 85 % RH | | | | | | |
| | Ambient illuminance | Incandescent light: 3,000 lx or less at the light-receiving face | | | | | | |
| | Voltage withstandability | 1,000 V AC for one min. between all supply terminals connected together and enclosure | | | | | | |
| | Insulation resistance | 20 MΩ, or more, with 250 V DC megger between all supply terminals connected together and enclosure | | | | | | |
| | Vibration resistance | 10 to 500 Hz frequency, 1.5 mm 0.059 in double amplitude (10 G max.) in X, Y and Z directions for two hours each | | | | | | |
| | Shock resistance | 500 m/s ² acceleration (50 G approx.) in X, Y and Z directions three times each | | | | | | |
| Emitting element (modulated) | | Red LED | | Infrared LED | | Red LED | | |
| | Peak emission wavelength | 680 nm 0.027 mil | | 870 nm 0.034 mil | | 680 nm 0.027 mil | | |
| Material | | Enclosure: PBT (Polybutylene terephthalate), Lens: Acrylic, Indicator cover: Acrylic | | | | | | |
| Cable | | 0.2 mm ² 3-core (thru-beam type emitter: 2-core) cabtyre cable, 0.5 m 1.640 ft long | | | | | | |
| Cable extension | | Extension up to total 100 m 328.084 ft is possible with 0.3 mm ² , or more, cable (thru-beam type: both emitter and receiver) | | | | | | |
| Weight | Net | Emitter: 20 g approx., Receiver: 20 g approx. | | | | 20 g approx. | | |
| | Gross | 50 g approx. | | | | 30 g approx. | | |

Notes: 1) Where measurement conditions have not been specified precisely, the conditions used were an ambient temperature of +23 °C **+73.4 °F**.
 2) The sensing range and the sensing object of the retroreflective type sensor are specified for the **RF-230** reflector (optional). The sensing range represents the actual sensing range of the sensor. The sensing range : A of the table below may vary depending on the shape of sensing object. Be sure to check the operation with the actual sensing object.

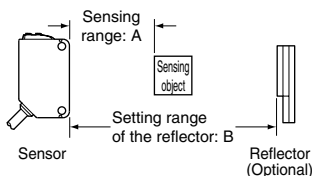

| | CX-491□ |
|---|--|
| A | 0 to 3 m 0 to 9.843 ft |
| B | 0.1 to 3 m 0.328 to 9.843 ft |

3) If slit masks (optional) are fitted, an object of ø0.5 mm **ø0.020 in** (using round slit mask) can be detected.
 4) Make sure to confirm detection with an actual sensor before use.

I/O CIRCUIT AND WIRING DIAGRAMS

NPN output type

I/O circuit diagram

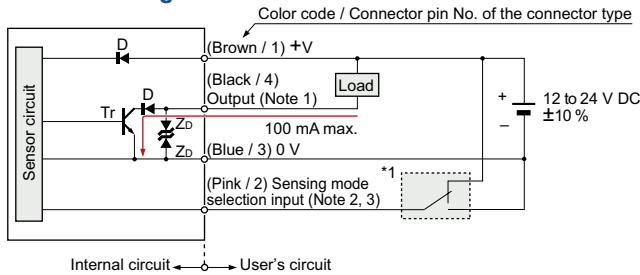

- Notes: 1) The emitter of the thru-beam type sensor does not incorporate the output.
2) Sensing mode selection input is incorporated only for the **CX-44** adjustable range reflective type. When using the **CX-44**, be sure to wire the sensing mode selection input (pink / 2) as mentioned *1. Unstable operation may occur.
3) When the mating cable is connected to the plug-in connector type of **CX-44**, its color is white.

*1

- Sensing mode selection input
BGS function: Connect to 0 V
FGS function: Connect to +V

Symbols ... D : Reverse supply polarity protection diode
Z_D : Surge absorption zener diode
Tr : NPN output transistor

Wiring diagram

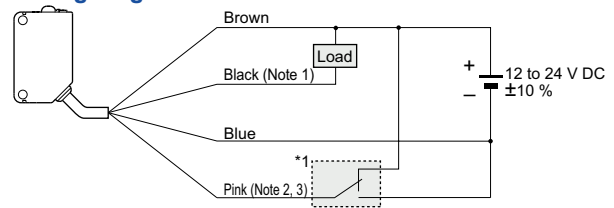

- Notes: 1) The emitter of the thru-beam type sensor does not incorporate the black wire.
2) The pink wire is incorporated only for the **CX-44** adjustable range reflective type. When using the **CX-44**, be sure to wire the pink wire as mentioned *1. Unstable operation may occur.
3) When the mating cable is connected to the plug-in connector type of **CX-44**, its color is white.

*1

- Sensing mode selection input
BGS function: Connect to 0 V
FGS function: Connect to +V

Connector pin position

M8 plug-in connector type

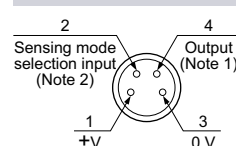

M12 pigtailed type

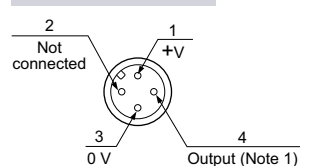

- Notes: 1) The emitter of the thru-beam type sensor does not incorporate the output.
2) Sensing mode selection input is incorporated only for the **CX-44** adjustable range reflective type. When using the **CX-44**, be sure to wire the sensing mode selection input (pink / 2). Unstable operation may occur.

PNP output type

I/O circuit diagram

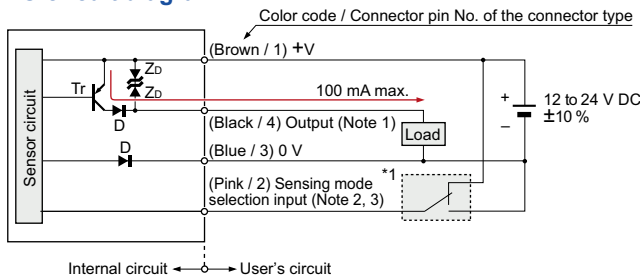

- Notes: 1) The emitter of the thru-beam type sensor does not incorporate the output.
2) Sensing mode selection input is incorporated only for the **CX-44-P** adjustable range reflective type. When using the **CX-44-P**, be sure to wire the sensing mode selection input (pink / 2) as mentioned *1. Unstable operation may occur.
3) When the mating cable is connected to the plug-in connector type of **CX-44-P**, its color is white.

*1

- Sensing mode selection input
BGS function: Connect to 0 V
FGS function: Connect to +V

Symbols ... D : Reverse supply polarity protection diode
Z_D : Surge absorption zener diode
Tr : PNP output transistor

Wiring diagram

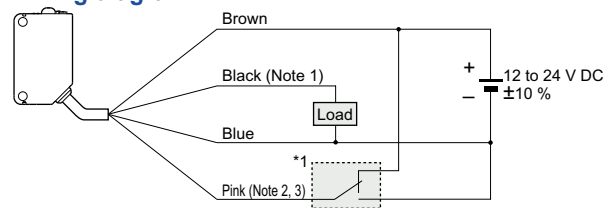

- Notes: 1) The emitter of the thru-beam type sensor does not incorporate the black wire.
2) The pink wire is incorporated only for the **CX-44-P** adjustable range reflective type. When using the **CX-44-P**, be sure to wire the pink wire as mentioned *1. Unstable operation may occur.
3) When the mating cable is connected to the plug-in connector type of **CX-44-P**, its color is white.

*1

- Sensing mode selection input
BGS function: Connect to 0 V
FGS function: Connect to +V

Connector pin position

M8 plug-in connector type

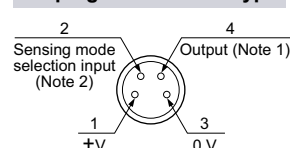

M12 pigtailed type

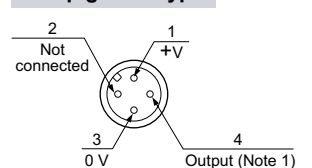

- Notes: 1) The emitter of the thru-beam type sensor does not incorporate the output.
2) Sensing mode selection input is incorporated only for the **CX-44-P** adjustable range reflective type. When using the **CX-44-P**, be sure to wire the sensing mode selection input (pink / 2). Unstable operation may occur.

FIBER SENSORS

LASER SENSORS

PHOTO-ELECTRIC SENSORS

MICRO PHOTO-ELECTRIC SENSORS

AREA SENSORS

SAFETY LIGHT CURTAINS / SAFETY COMPONENTS

PRESSURE / FLOW SENSORS

INDUCTIVE PROXIMITY SENSORS

PARTICULAR USE SENSORS

SENSOR OPTIONS

SIMPLE WIRE-SAVING UNITS

WIRE-SAVING SYSTEMS

MEASUREMENT SENSORS

STATIC CONTROL DEVICES

LASER MARKERS

PLC

HUMAN MACHINE INTERFACES

ENERGY MANAGEMENT SOLUTIONS

FA COMPONENTS

MACHINE VISION SYSTEMS

UV CURING SYSTEMS

Selection Guide

Amplifier Built-in

Power Supply Built-in

Amplifier-separated

EX-Z

CX-400

CY-100

EX-10

EX-20

EX-30

EX-40

CX-440

EQ-30

EQ-500

MQ-W

RX-LS200

RX

RT-610

SENSING CHARACTERISTICS (TYPICAL)

Please contact our office for the sensing characteristics of CX-413 and CX-483.

CX-411□

Thru-beam type

Parallel deviation

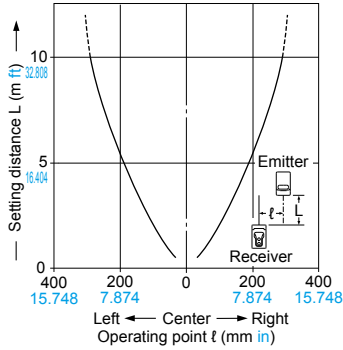

Angular deviation

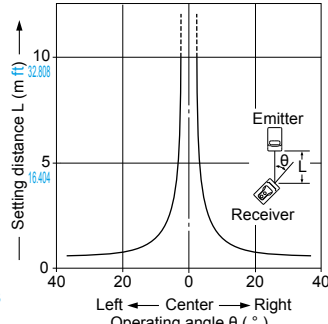

Parallel deviation with round slit masks (ø0.5 mm ø0.020 in)

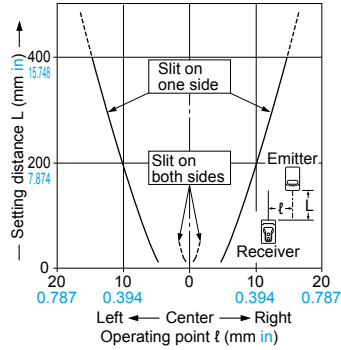

Parallel deviation with round slit masks (ø1 mm ø0.039 in)

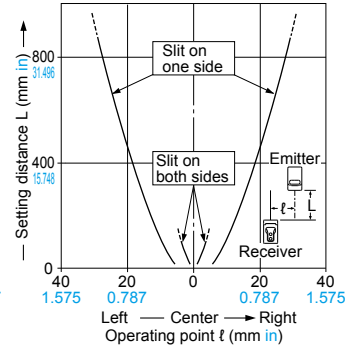

Parallel deviation with round slit masks (ø2 mm ø0.079 in)

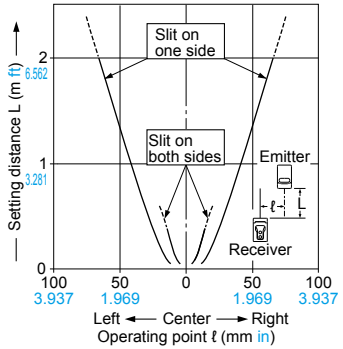

Parallel deviation with rectangular slit masks (0.5 x 6 mm 0.020 x 0.236 in)

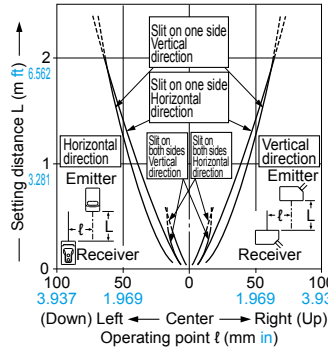

Parallel deviation with rectangular slit masks (1 x 6 mm 0.039 x 0.236 in)

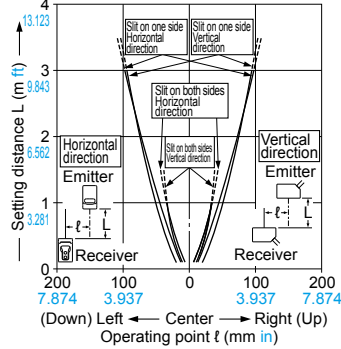

Parallel deviation with rectangular slit masks (2 x 6 mm 0.079 x 0.236 in)

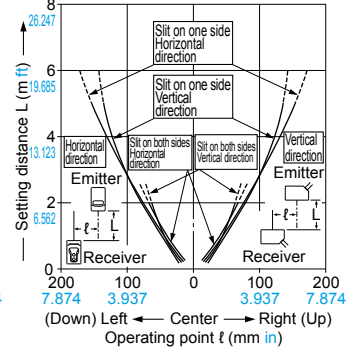

CX-412□

Thru-beam type

Parallel deviation

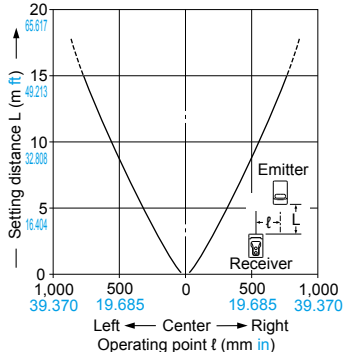

Angular deviation

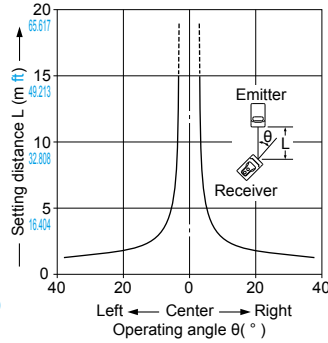

Parallel deviation with round slit masks (ø0.5 mm ø0.020 in)

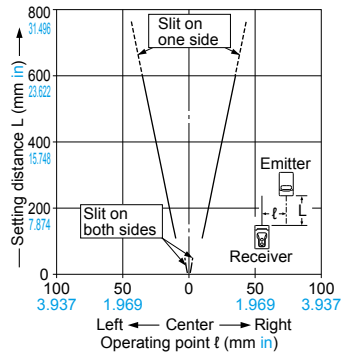

Parallel deviation with round slit masks (ø1 mm ø0.039 in)

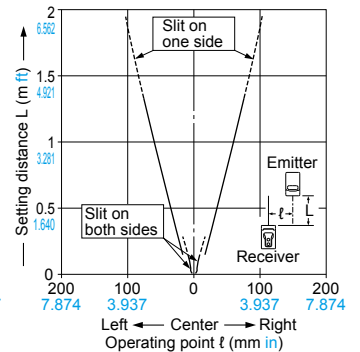

Parallel deviation with round slit masks (ø2 mm ø0.079 in)

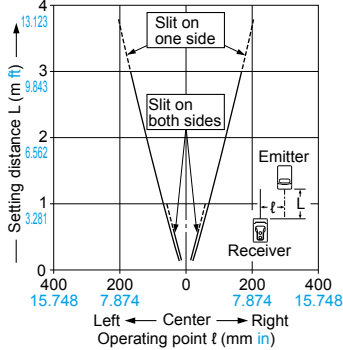

Parallel deviation with rectangular slit masks (0.5 x 6 mm 0.020 x 0.236 in)

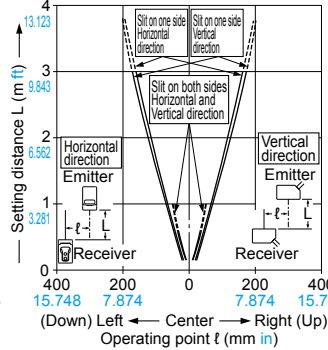

Parallel deviation with rectangular slit masks (1 x 6 mm 0.039 x 0.236 in)

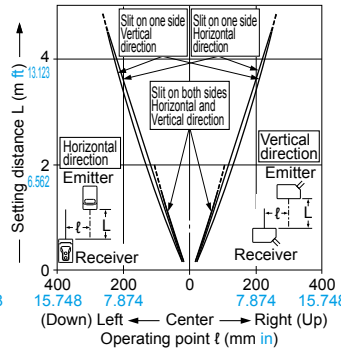

Parallel deviation with rectangular slit masks (2 x 6 mm 0.079 x 0.236 in)

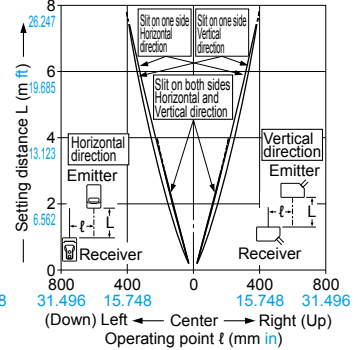

FIBER SENSORS

LASER SENSORS

PHOTO-ELECTRIC SENSORS

MICRO PHOTO-ELECTRIC SENSORS

AREA SENSORS

SAFETY LIGHT CURTAINS / SAFETY COMPONENTS

PRESSURE / FLOW SENSORS

INDUCTIVE PROXIMITY SENSORS

PARTICULAR USE SENSORS

SENSOR OPTIONS

WIRE-SAVING UNITS

WIRE-SAVING SYSTEMS

MEASUREMENT SENSORS

STATIC CONTROL DEVICES

LASER MARKERS

PLC

HUMAN MACHINE INTERFACES

ENERGY MANAGEMENT SOLUTIONS

FA COMPONENTS

MACHINE VISION SYSTEMS

UV CURING SYSTEMS

Selection Guide

Amplifier Built-in

Power Supply Built-in

Amplifier-separated

EX-Z

CX-400

CY-100

EX-10

EX-20

EX-30

EX-40

CX-440

EQ-30

EQ-500

MQ-W

RX-LS200

RX

RT-610

SENSING CHARACTERISTICS (TYPICAL)

Please contact our office for the sensing characteristics of **CX-413** and **CX-483**.

FIBER SENSORS

LASER SENSORS

PHOTO-ELECTRIC SENSORS

MICRO PHOTO-ELECTRIC SENSORS

AREA SENSORS

SAFETY LIGHT CURTAINS / SAFETY COMPONENTS

PRESSURE / FLOW SENSORS

INDUCTIVE PROXIMITY SENSORS

PARTICULAR USE SENSORS

SENSOR OPTIONS

SIMPLE WIRE-SAVING UNITS

WIRE-SAVING SYSTEMS

MEASUREMENT SENSORS

STATIC CONTROL DEVICES

LASER MARKERS

PLC

HUMAN MACHINE INTERFACES

ENERGY MANAGEMENT SOLUTIONS

FA COMPONENTS

MACHINE VISION SYSTEMS

UV CURING SYSTEMS

Selection Guide

Amplifier Built-in

Power Supply Built-in

Amplifier-separated

EX-Z

CX-400

CY-100

EX-10

EX-20

EX-30

EX-40

CX-440

EQ-30

EQ-500

MQ-W

RX-LS200

RX

RT-610

CX-491□

Retroreflective type

Parallel deviation

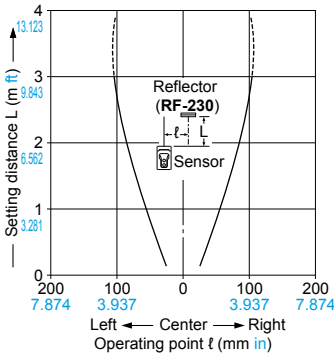

Angular deviation

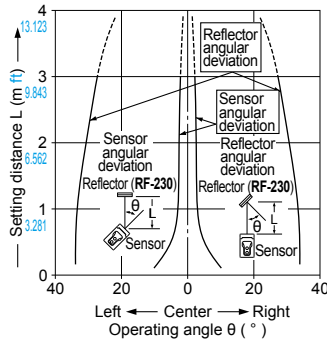

CX-493□

Retroreflective type

Parallel deviation

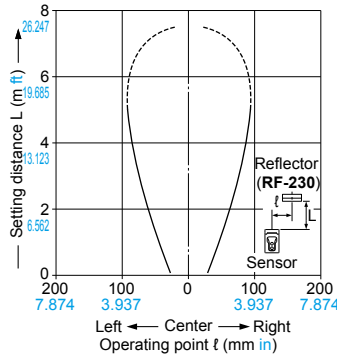

Angular deviation

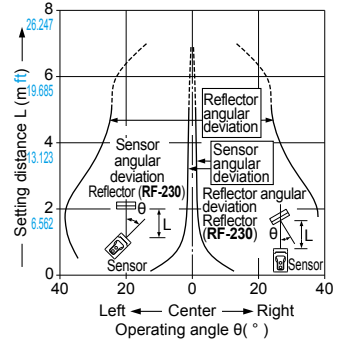

CX-481□

Retroreflective type

Parallel deviation

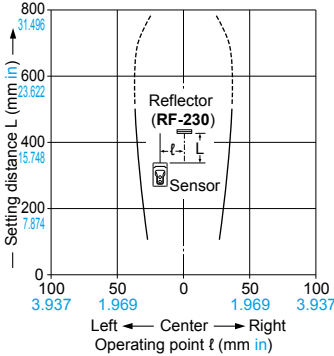

Angular deviation

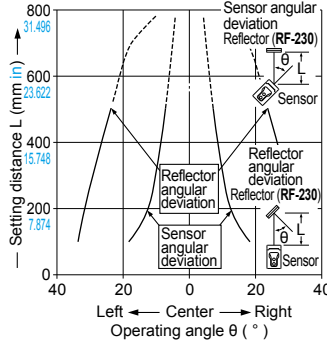

CX-482□

Retroreflective type

Parallel deviation

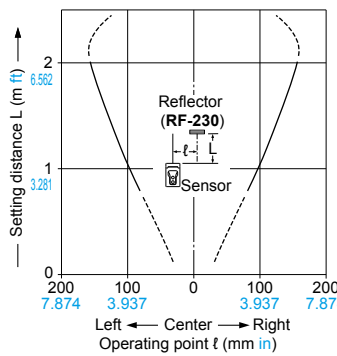

Angular deviation

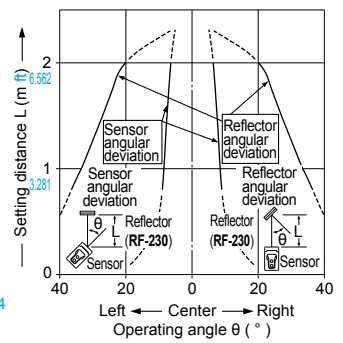

CX-424□

Diffuse reflective type

Sensing field

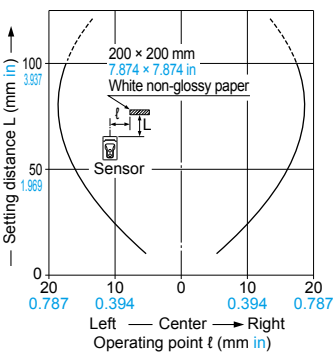

Correlation between sensing object size and sensing range

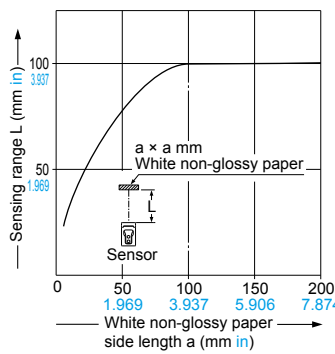

As the sensing object size becomes smaller than the standard size (white non-glossy paper 200 × 200 mm 7.874 × 7.874 in), the sensing range shortens, as shown in the left graph.

(For plotting the left graph, the sensitivity has been set such that a 200 × 200 mm 7.874 × 7.874 in white non-glossy paper is just detectable at a distance of 100 mm 3.937 in.)

CX-421□

Diffuse reflective type

Sensing field

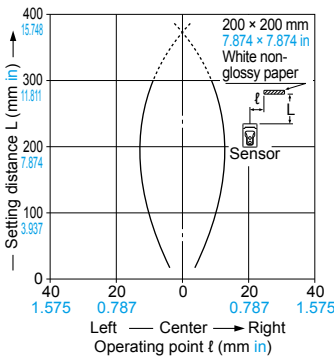

SENSING CHARACTERISTICS (TYPICAL)

FIBER SENSORS
LASER SENSORS
PHOTO-ELECTRIC SENSORS
MICRO PHOTO-ELECTRIC SENSORS
AREA SENSORS
SAFETY LIGHT CURTAINS / SAFETY COMPONENTS
PRESSURE / FLOW SENSORS
INDUCTIVE PROXIMITY SENSORS
PARTICULAR USE SENSORS
SENSOR OPTIONS
SIMPLE WIRE-SAVING UNITS
WIRE-SAVING SYSTEMS
MEASURE-MENT SENSORS
STATIC CONTROL DEVICES
LASER MARKERS
PLC
HUMAN MACHINE INTERFACES
ENERGY MANAGEMENT SOLUTIONS
FA COMPONENTS
MACHINE VISION SYSTEMS
UV CURING SYSTEMS
Selection Guide
Amplifier Built-in
Power Supply Built-in
Amplifier-separated

Diffuse reflective type

CX-422□

Sensing field

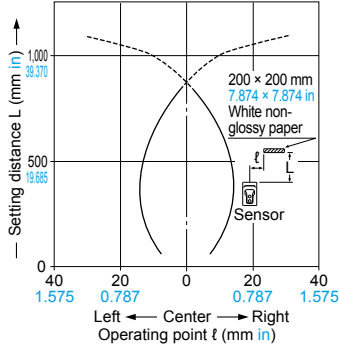

Correlation between sensing object size and sensing range

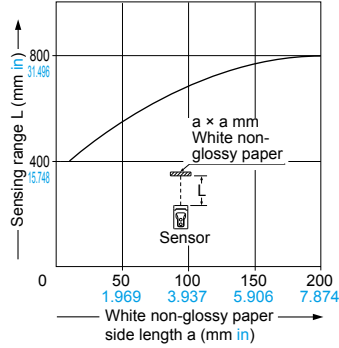

As the sensing object size becomes smaller than the standard size (white non-glossy paper 200 × 200 mm 7.874 × 7.874 in), the sensing range shortens, as shown in the left graph.

(For plotting the left graph, the sensitivity has been set such that a 200 × 200 mm 7.874 × 7.874 in white non-glossy paper is just detectable at a distance of 800 mm 31.496 in.)

CX-423□

Diffuse reflective type

Sensing field

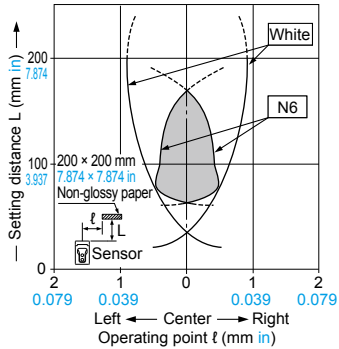

Correlation between sensing object size and sensing range

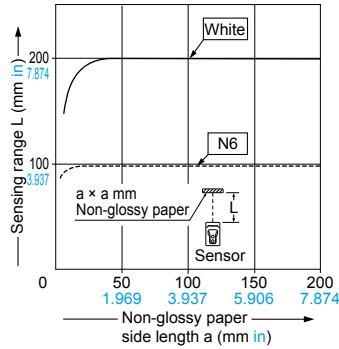

As the sensing object size becomes smaller than the standard size (white non-glossy paper 200 × 200 mm 7.874 × 7.874 in), the sensing range shortens, as shown in the left graph.

(For plotting the left graph, the sensitivity has been set such that a 200 × 200 mm 7.874 × 7.874 in white non-glossy paper is just detectable at a distance of 200 mm 7.874 in. Contact us for the sensing characteristics of 300 mm 11.811 in. Please contact us for the sensing field at the setting distance 300 mm 11.811 in.)

Correlation between lightness and sensing range

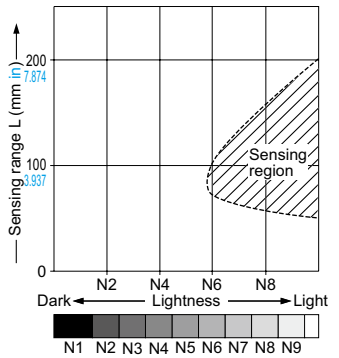

The sensing region is represented by oblique lines in the left figure. However, the sensitivity should be set with an enough margin because of slight variation in products.

(Lightness shown on the left may differ slightly from the actual object condition.)

Emitted beam

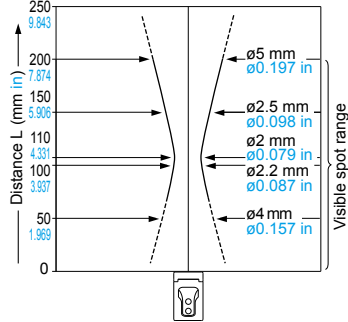

EX-Z

CX-400

CY-100

EX-10

EX-20

EX-30

EX-40

CX-440

EQ-30

EQ-500

MQ-W

RX-LS200

RX

RT-610

SENSING CHARACTERISTICS (TYPICAL)

CX-441□

Adjustable range reflective type

Sensing fields

• Setting distance: 25 mm 0.984 in

• Setting distance: 50 mm 1.969 in

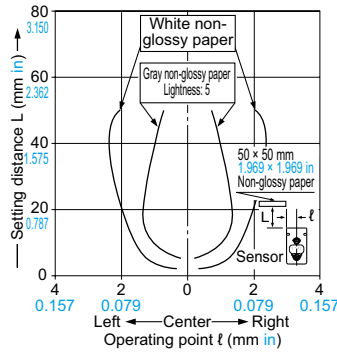
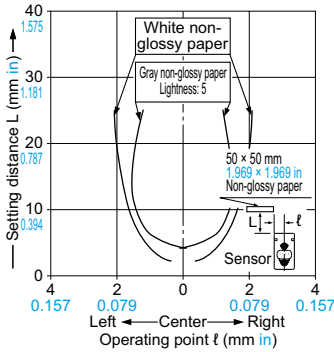

Emitted beam

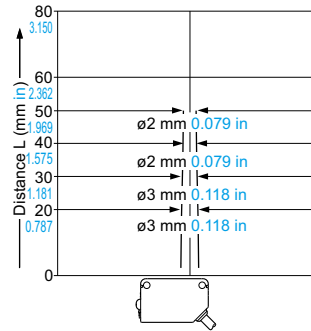

Correlation between color

(50 × 50 mm 1.969 × 1.969 in construction paper) and sensing range

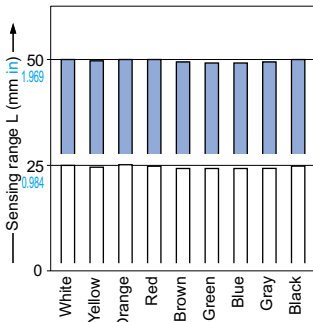

These bars indicate the sensing range with the respective colors when the distance adjuster is set to a sensing range of 50 mm 1.969 in and 25 mm 0.984 in long, respectively, with white color. The sensing range also varies depending on material.

Correlation between material

(50 × 50 mm 1.969 × 1.969 in) and sensing range

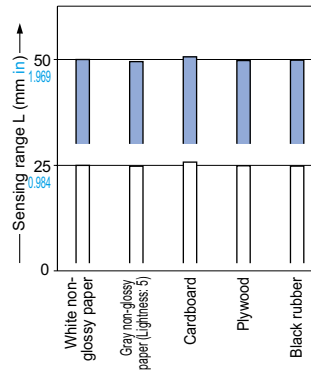

These bars indicate the sensing range with the respective objects when the distance adjuster is set to a sensing range of 50 mm 1.969 in and 25 mm 0.984 in long, respectively, with white non-glossy paper.

CX-443□

Adjustable range reflective type

Sensing fields

• Setting distance: 25 mm 0.984 in

• Setting distance: 50 mm 1.969 in

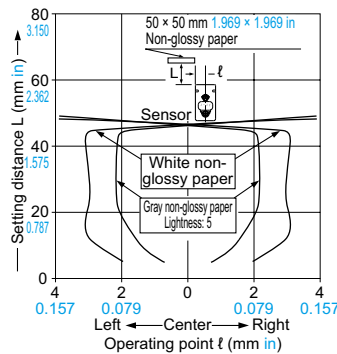
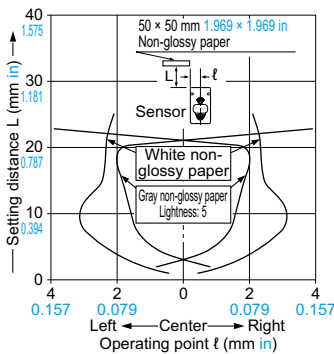

Emitted beam

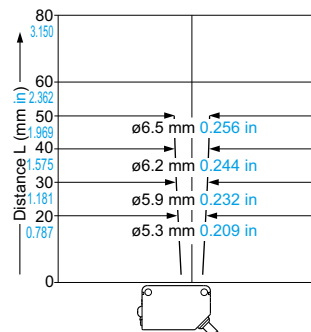

Correlation between color

(50 × 50 mm 1.969 × 1.969 in construction paper) and sensing range

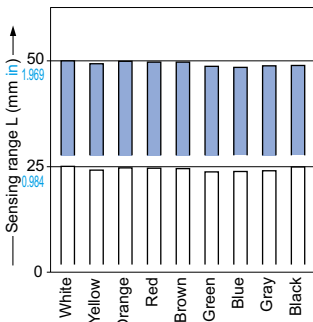

These bars indicate the sensing range with the respective colors when the distance adjuster is set to a sensing range of 50 mm 1.969 in and 25 mm 0.984 in long, respectively, with white color. The sensing range also varies depending on material.

Correlation between material

(50 × 50 mm 1.969 × 1.969 in) and sensing range

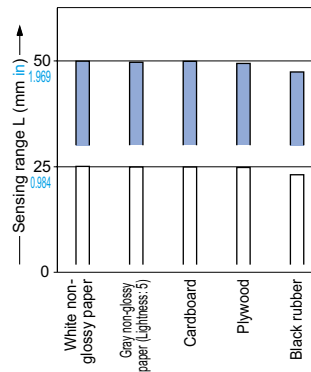

These bars indicate the sensing range with the respective objects when the distance adjuster is set to a sensing range of 50 mm 1.969 in and 25 mm 0.984 in long, respectively, with white non-glossy paper.

FIBER SENSORS

LASER SENSORS

PHOTO-ELECTRIC SENSORS

MICRO PHOTO-ELECTRIC SENSORS

AREA SENSORS

SAFETY LIGHT CURTAINS / SAFETY COMPONENTS

PRESSURE / FLOW SENSORS

INDUCTIVE PROXIMITY SENSORS

PARTICULAR USE SENSORS

SENSOR OPTIONS

SIMPLE WIRE-SAVING UNITS

WIRE-SAVING SYSTEMS

MEASUREMENT SENSORS

STATIC CONTROL DEVICES

LASER MARKERS

PLC

HUMAN MACHINE INTERFACES

ENERGY MANAGEMENT SOLUTIONS

FA COMPONENTS

MACHINE VISION SYSTEMS

UV CURING SYSTEMS

Selection Guide

Amplifier Built-in

Power Supply Built-in

Amplifier-separated

EX-Z

CX-400

CY-100

EX-10

EX-20

EX-30

EX-40

CX-440

EQ-30

EQ-500

MQ-W

RX-LS200

RX

RT-610

SENSING CHARACTERISTICS (TYPICAL)

FIBER SENSORS
LASER SENSORS
PHOTO-ELECTRIC SENSORS
MICRO PHOTO-ELECTRIC SENSORS
AREA SENSORS
SAFETY LIGHT CURTAINS / SAFETY COMPONENTS
PRESSURE / FLOW SENSORS
INDUCTIVE PROXIMITY SENSORS
PARTICULAR USE SENSORS
SENSOR OPTIONS
SIMPLE WIRE-SAVING UNITS
WIRE-SAVING SYSTEMS
MEASUREMENT SENSORS
STATIC CONTROL DEVICES
LASER MARKERS
PLC
HUMAN MACHINE INTERFACES
ENERGY MANAGEMENT SOLUTIONS
FA COMPONENTS
MACHINE VISION SYSTEMS
UV CURING SYSTEMS
Selection Guide
Amplifier Built-in
Power Supply Built-in
Amplifier-separated
EX-Z
CX-400
CY-100
EX-10
EX-20
EX-30
EX-40
CX-440
EQ-30
EQ-500
MQ-W
RX-LS200
RX
RT-610

CX-444 □

Adjustable range reflective type

Sensing fields

• Setting distance: 25 mm 0.984 in

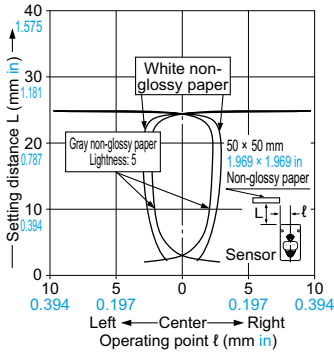

• Setting distance: 50 mm 1.969 in

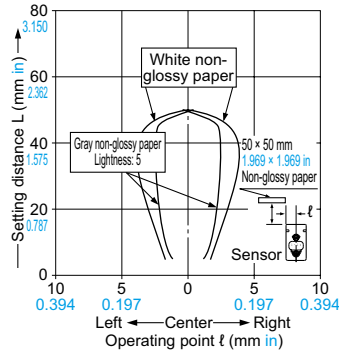

• Setting distance: 100 mm 3.937 in

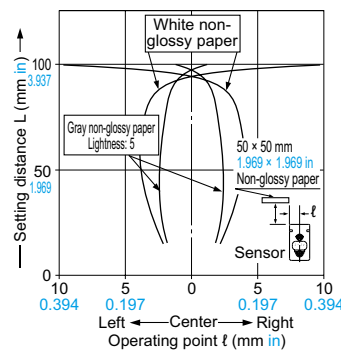

Emitted beam

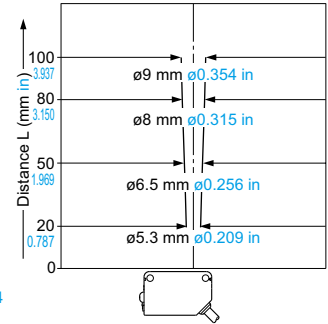

Correlation between color

(50 × 50 mm 1.969 × 1.969 in construction paper) and sensing range

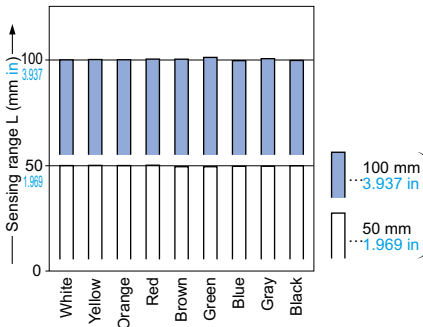

These bars indicate the sensing range with the respective colors when the distance adjuster is set to a sensing range of 100 mm 3.937 in and 50 mm 1.969 in long, respectively, with white color. The sensing range also varies depending on material.

Correlation between material

(50 × 50 mm 1.969 × 1.969 in) and sensing range

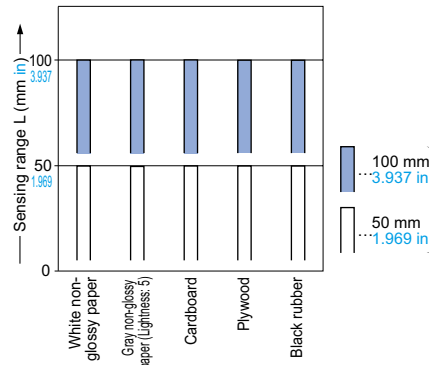

These bars indicate the sensing range with the respective objects when the distance adjuster is set to a sensing range of 100 mm 3.937 in and 50 mm 1.969 in long, respectively, with white non-glossy paper.

CX-442 □

Adjustable range reflective type

Sensing fields

• Setting distance: 100 mm 3.937 in

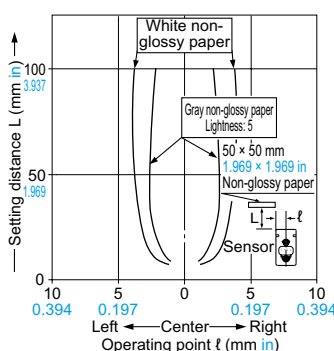

• Setting distance: 200 mm 7.874 in

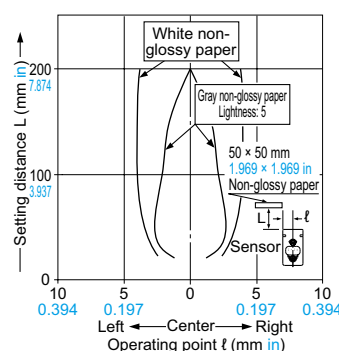

• Setting distance: 300 mm 11.811 in

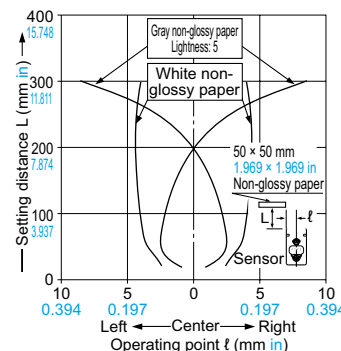

Emitted beam

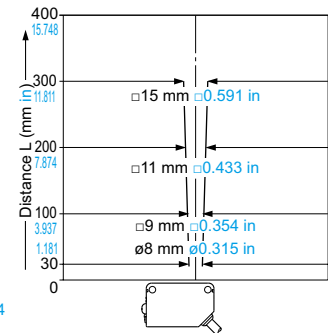

Correlation between color

(50 × 50 mm 1.969 × 1.969 in construction paper) and sensing range

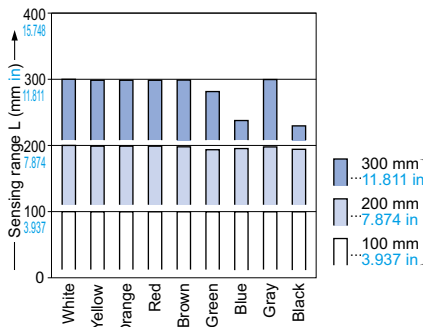

These bars indicate the sensing range with the respective colors when the distance adjuster is set to a sensing range of 300 mm 11.811 in, 200 mm 7.874 in and 100 mm 3.937 in long, respectively, with white color. The sensing range also varies depending on material.

Correlation between material

(50 × 50 mm 1.969 × 1.969 in) and sensing range

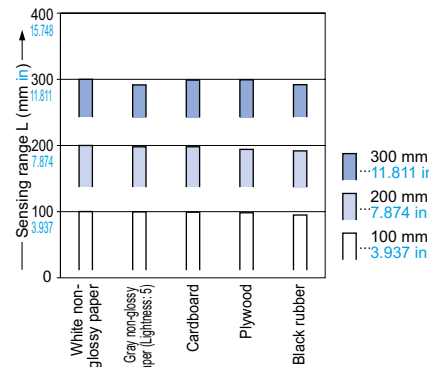

These bars indicate the sensing range with the respective objects when the distance adjuster is set to a sensing range of 300 mm 11.811 in, 200 mm 7.874 in and 100 mm 3.937 in long, respectively, with white non-glossy paper.

PRECAUTIONS FOR PROPER USE

Refer to p.1552~ for general precautions.

All models



- Never use this product as a sensing device for personnel protection.
- In case of using sensing devices for personnel protection, use products which meet laws and standards, such as OSHA, ANSI or IEC etc., for personnel protection applicable in each region or country.

Mounting

- The tightening torque should be 0.5 N·m or less.

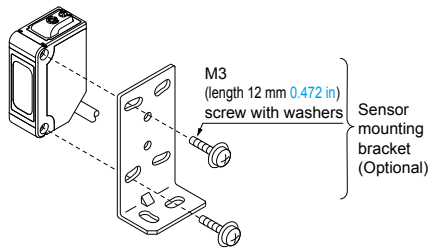

Others

- Do not use during the initial transient time (50 ms) after the power supply is switched on.

CX-41 □ CX-42 □ CX-49 □ CX-48 □

Part description and functions

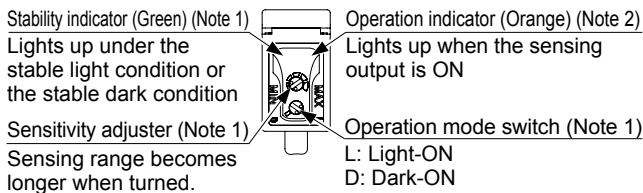

- Notes: 1) Not incorporated on the emitter.
 2) It is the power indicator (green, lights up when the power is ON.) on the emitter.

Operation mode switch

| Operation mode switch | Description |
|-----------------------|--|
| | Light-ON mode is obtained when the operation mode switch (thru-beam type incorporate it in the emitter) is turned fully clockwise (L side). |
| | Dark-ON mode is obtained when the operation mode switch (thru-beam type incorporate it in the receiver) is turned fully counter-clockwise (D side). |

Beam alignment

Thru-beam type

1. Set the operation mode switch to the Light-ON mode position (L side).
2. Place the emitter and the receiver face to face along a straight line, move the emitter in the up, down, left and right directions, in order to determine the range of the light received condition with the help of the operation indicator (orange). Then, set the emitter at the center of this range.
3. Similarly, adjust for up, down, left and right angular movement of the emitter.
4. Further, perform the angular adjustment for the receiver also.
5. Check that the stability indicator (green) lights up.
6. Choose the operation mode, Light-ON or Dark-ON, as per your requirement, with the operation mode switch.

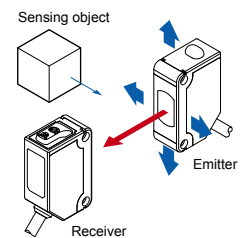

Retroreflective type

1. Set the operation mode switch to the Light-ON mode position (L side).
2. Placing the sensor and the reflector face to face along a straight line, move the reflector in the up, down, left and right directions, in order to determine the range of the light received condition with the help of the operation indicator (orange). Then, set the reflector at the center of this range.
3. Similarly, adjust for up, down, left and right angular movement of the reflector.
4. Further, perform the angular adjustment for the sensor also.
5. Check that the stability indicator (green) lights up.
6. Choose the operation mode, Light-ON or Dark-ON, as per your requirement, with the operation mode switch.

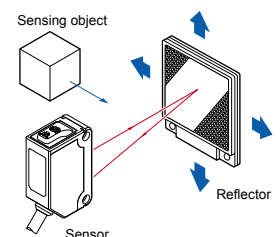

FIBER SENSORS

LASER SENSORS

PHOTO-ELECTRIC SENSORS

MICRO PHOTO-ELECTRIC SENSORS

AREA SENSORS

SAFETY LIGHT CURTAINS / SAFETY COMPONENTS

PRESSURE / FLOW SENSORS

INDUCTIVE PROXIMITY SENSORS

PARTICULAR USE SENSORS

SENSOR OPTIONS

SIMPLE WIRE-SAVING UNITS

WIRE-SAVING SYSTEMS

MEASURE-MENT SENSORS

STATIC CONTROL DEVICES

LASER MARKERS

PLC

HUMAN MACHINE INTERFACES

ENERGY MANAGEMENT SOLUTIONS

FA COMPONENTS

MACHINE VISION SYSTEMS

UV CURING SYSTEMS

Selection Guide

Amplifier Built-in

Power Supply Built-in

Amplifier-separated

EX-Z

CX-400

CY-100

EX-10

EX-20

EX-30

EX-40

CX-440

EQ-30

EQ-500

MQ-W

RX-LS200

RX

RT-610

PRECAUTIONS FOR PROPER USE

Refer to p.1552~ for general precautions.

CX-41□ CX-42□ CX-49□ CX-48□

Sensitivity adjustment

| Step | Sensitivity adjuster | Description |
|------|----------------------|--|
| ① | | Turn the sensitivity adjuster fully counterclockwise to the minimum sensitivity position, MIN. |
| ② | | In the light received condition, turn the sensitivity adjuster slowly clockwise and confirm the point (A) where the sensor enters the "Light" state operation. |
| ③ | | In the dark condition, turn the sensitivity adjuster further clockwise until the sensor enters the "Light" state operation and then bring it back to confirm point (B) where the sensor just returns to the "Dark" state operation. (If the sensor does not enter the "Light" state operation even when the sensitivity adjuster is turned fully clockwise, the position is point (B).) |
| ④ | | The position at the middle of points (A) and (B) is the optimum sensing position. |

Note: Use the flathead screwdriver (purchase separately) to turn the adjuster slowly. Turning with excessive strength will cause damage to the adjuster.

| | Light condition | Dark condition |
|-------------------------|-----------------|----------------|
| Thru-beam type | | |
| Retroreflective type | | |
| Diffuse reflective type | | |

Relation between output and indicators

| In case of Light-ON | | | Sensing condition | In case of Dark-ON | | |
|---------------------|---------------------|--------|--------------------------|--------------------|---------------------|---------------------|
| Stability indicator | Operation indicator | Output | | Output | Operation indicator | Stability indicator |
| ● | ● | ON | Stable light receiving | OFF | ● | ● |
| ● | ● | ON | Unstable light receiving | OFF | ● | ● |
| ● | ● | OFF | Unstable dark receiving | ON | ● | ● |
| ● | ● | OFF | Stable dark receiving | ON | ● | ● |

●, ●: Lights up, ●: Turns OFF

Retroreflective type sensor (excluding CX-491□)

- Please take care of the following points when detecting materials having a gloss.

- ① Make L, shown in the diagram, sufficiently long.
- ② Install at an angle of 10 to 30 degrees to the sensing object.

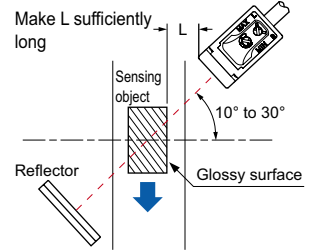

Retroreflective type sensor with polarizing filters (CX-491□)

- If a shiny object is covered or wrapped with a transparent film, such as those described below, the retroreflective type sensor with polarizing filters may not be able to detect it. In that case, follow the steps given below.

Example of sensing objects

- Can wrapped by clear film
- Aluminum sheet covered by plastic film
- Gold or silver color (specular) label or wrapping paper

Steps

- Tilt the sensor with respect to the sensing object while fitting.
- Reduce the sensitivity.
- Increase the distance between the sensor and the sensing object.

CX-48□

Retroreflective type sensor for transparent object sensing (CX-48□)

- Optimum sensing is possible when the position of the transparent sensing object is set at the center of the sensor and the reflector. If the sensing position is set near the sensor or the reflector, the sensing may be unstable. In this case, set the sensing position at the center of the sensor and the reflector.

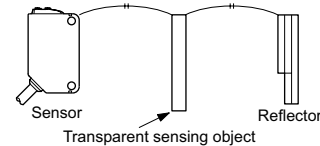

- When the sensor detects an uneven plastic receptacle or glass bottle, the received-light amount may differ with the sensing position or direction. Adjust the sensitivity after confirming the stable sensing condition by turning the sensing object, etc.
- When sensing pipe-shaped transparent sensing object, set it in a standing, not lying, position as shown in Figure A. The sensor may fail to detect a lying object as shown in Figure B.

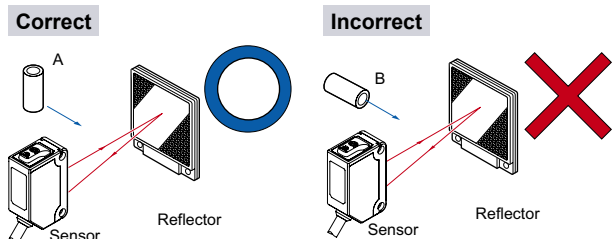

PRECAUTIONS FOR PROPER USE

Refer to p.1552~ for general precautions.

CX-41□

Slit mask (Optional)

- With the slit mask **OS-CX-□**, the sensor can detect a small object. However, the sensing range is reduced when the slit mask is mounted.

How to mount

1. Insert the fixing hook into the fixing groove.
2. Then, pressing the slit mask against the main unit, insert the fixing tab into the fixing groove.

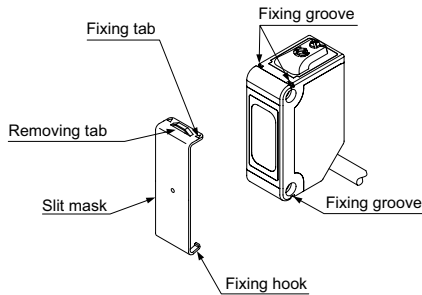

How to remove

1. Insert a screwdriver into the removing tab.
2. Pull forward while lifting the removing tab.

CX-44□

Mounting

- Care must be taken regarding the sensor mounting direction with respect to the object's direction of movement.

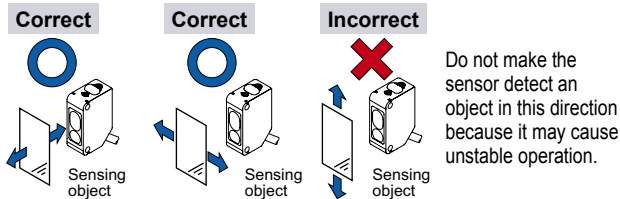

- When detecting a specular object (aluminum or copper foil, etc.) or an object having a glossy surface or coating, please take care that there are cases when the object may not be detected due to a change in angle, wrinkles on the object surface, etc.
- When a specular body is present below the sensor, use the sensor by tilting it slightly upwards to avoid wrong operation.

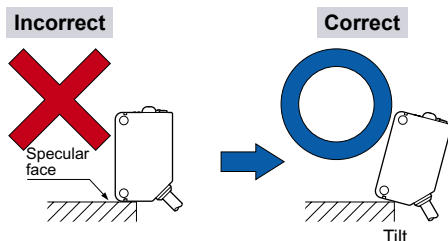

- If a specular body is present in the background, wrong operation may be caused due to a small change in the angle of the background body. In that case, install the sensor at an inclination and confirm the operation with the actual sensing object.
- Take care that there is a non-detectable area right in front of the sensor.

Interference prevention filter (CX-411□)

- By mounting the interference prevention filters **PF-CX4-□**, two sets of the **CX-411□** can be mounted close together. However, the sensing range is reduced when the interference prevention filter is mounted.
- The filters can be mounted by the same method as for the slit masks.
- Since there are two types of the interference prevention filter, the two sets of sensors should be fitted with different types of interference prevention filters, as shown in the figure below. The interference prevention does not work even if the filters are mounted for emitters only, receivers only or the same model No. of the interference prevention filters are mounted on both the sets of the sensor.

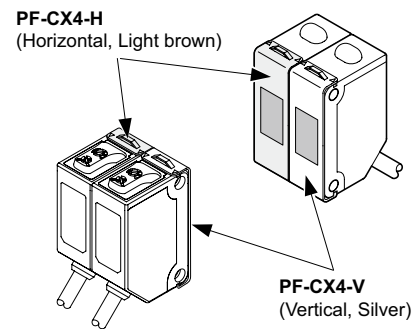

Operation mode switch

| Operation mode switch | Description |
|-----------------------|---|
| | Detecting-ON mode is obtained when the operation mode switch is turned fully clockwise (L side). |
| | Not detecting-ON is obtained when the operation mode switch is turned fully counterclockwise (D side) |

Note: Use the flathead screwdriver (purchase separately) to turn the operation mode switch slowly. Turning with excessive strength will cause damage to the adjuster.

- Depending on whether you select the BGS or FGS function, the output operation changes as follows.

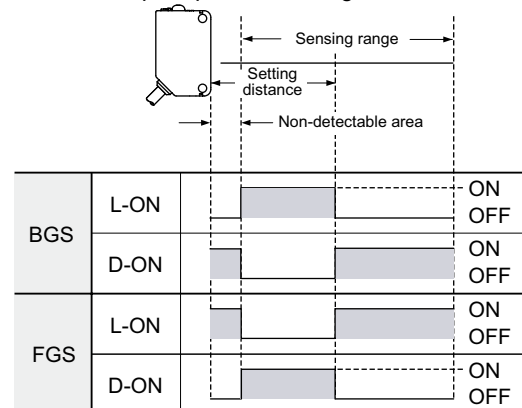

FIBER SENSORS
LASER SENSORS
PHOTO-ELECTRIC SENSORS
MICRO PHOTO-ELECTRIC SENSORS
AREA SENSORS
SAFETY LIGHT CURTAINS / SAFETY COMPONENTS
PRESSURE / FLOW SENSORS
INDUCTIVE PROXIMITY SENSORS
PARTICULAR USE SENSORS
SENSOR OPTIONS
SIMPLE WIRE-SAVING UNITS
WIRE-SAVING SYSTEMS
MEASUREMENT SENSORS
STATIC CONTROL DEVICES
LASER MARKERS
PLC
HUMAN MACHINE INTERFACES
ENERGY MANAGEMENT SOLUTIONS
FA COMPONENTS
MACHINE VISION SYSTEMS
UV CURING SYSTEMS
Selection Guide
Amplifier Built-in
Power Supply Built-in
Amplifier-separated
EX-Z
CX-400
CY-100
EX-10
EX-20
EX-30
EX-40
CX-440
EQ-30
EQ-500
MQ-W
RX-LS200
RX
RT-610

PRECAUTIONS FOR PROPER USE

Refer to p.1552~ for general precautions.

CX-44□

Stability indicator

- Since the **CX-44□** use a 2-segment photodiode as its receiving element, and sensing is done based on the difference in the incident beam angle of the reflected beam from the sensing object, the output and the operation indicator (orange) operate according to the object distance. Further, the stability indicator (green) shows the margin to the setting distance.

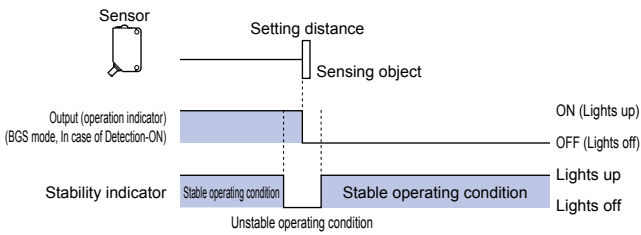

BGS/FGS functions

- This sensor incorporates BGS/FGS functions. Select either BGS or FGS function depending on the positions of the background and sensing object.

BGS function

- This function is used when the sensing object is apart from the background.

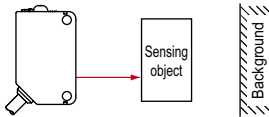

FGS function

- This function is used when the sensing object contacts the background or the sensing object is glossy, etc.
- Please use the FGS function together with a conveyor or other background unit.

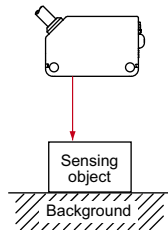

Distance adjustment



- When this product is used, be sure to carry out the distance adjustment.
- Since the distance adjuster of this sensor is a 5-turn adjuster, when the point (A) and (B) is adjusted as explained in the table right, there may be more than 1 turn between the point (A) and (B). Therefore, make sure to remember the turns of both points to find the optimum position.
- Be sure to wire the sensing mode selection input (Pink / 2) before distance adjustment. If the wiring is done after the distance adjustment, the sensing area is changed.

- Turn the distance adjuster gradually and lightly with a "minus" screwdriver (purchase separately). In order to protect itself, the distance adjuster idles if turned fully. If the adjuster is idled when distance adjustment is done, carry out the adjustment again.

When using the BGS function

<When a sensing object is moving right or left to the sensor>

| Step | Description | Distance adjuster |
|------|--|-------------------|
| ① | Turn the distance adjuster fully counterclockwise to the minimum sensing range position. (CX-441□/443□/444□ : 20 mm 0.787 in approx., CX-442□ : 40 mm 1.575 in approx.) | Turn fully |
| ② | Place an object at the required distance from the sensor, turn the distance adjuster gradually clockwise, and find out point (A) where the sensor changes to the detecting condition. | |
| ③ | Remove the object, turn the adjuster clockwise further until the sensor goes into the detecting state again. Once it has entered, turn the distance adjuster backward until the sensor returns to the non-detecting condition. This position is designated as point (B). When the sensor does not go into the detecting condition even if the adjuster is turned fully clockwise, the position where the adjuster was fully turned is regarded as the point (B). (There may be more than 1 turn between point (A) and (B), since this sensor incorporates a 5-turn adjuster.) | |
| ④ | The optimum position to stably detect objects is the center point between (A) and (B). | |

<When a sensing object is approaching / moving away from the sensor>

- Follow only steps ① and ②. Since the sensing point may change depending on the sensing object, be sure to check the operation with the actual sensing object.

When using the FGS function

- Please use the FGS function together with a conveyor or other background unit.

| Step | Description | Distance adjuster |
|------|--|-------------------|
| ① | Turn the distance adjuster fully clockwise to the maximum sensing range position. (CX-441□/443□ : 50 mm 1.969 in approx., CX-444□ : 100 mm 3.937 in approx., CX-442□ : 300 mm 11.811 in approx.) | Turn fully |
| ② | In the state where the sensor detects the background, turn the distance adjuster gradually counterclockwise, and find out point (A) where the sensor changes to the non-detecting condition. | |
| ③ | Place an object at the required distance from the sensor, turn the adjuster counterclockwise further until the sensor goes into the non-detecting condition again. Once entered, turn the distance adjuster backward until the sensor returns to the detecting condition. This position is designated as point (B). When the sensor does not go into the non-detecting condition even if the adjuster is turned fully counterclockwise, the position where the adjuster was fully turned is regarded as the point (B). (There may be more than 1 turn between point (A) and (B), since this sensor incorporates a 5-turn adjuster.) | |
| ④ | The optimum position to stably detect objects is the center point between (A) and (B). | |

Others

- Its distance adjuster is mechanically operated. Do not drop; avoid other shocks.

FIBER SENSORS
LASER SENSORS
PHOTO-ELECTRIC SENSORS
MICRO PHOTO-ELECTRIC SENSORS
AREA SENSORS
SAFETY LIGHT CURTAINS / SAFETY COMPONENTS
PRESSURE / FLOW SENSORS
INDUCTIVE PROXIMITY SENSORS
PARTICULAR USE SENSORS
SENSOR OPTIONS
SIMPLE WIRE-SAVING UNITS
WIRE-SAVING SYSTEMS
MEASUREMENT SENSORS
STATIC CONTROL DEVICES
LASER MARKERS
PLC
HUMAN MACHINE INTERFACES
ENERGY MANAGEMENT SOLUTIONS
FA COMPONENTS
MACHINE VISION SYSTEMS
UV CURING SYSTEMS
Selection Guide
Amplifier Built-in
Power Supply Built-in
Amplifier-separated
EX-Z
CX-400
CY-100
EX-10
EX-20
EX-30
EX-40
CX-440
EQ-30
EQ-500
MQ-W
RX-LS200
RX
RT-610

DIMENSIONS (Unit: mm in)

The CAD data can be downloaded from our website.

CX-41 Sensor

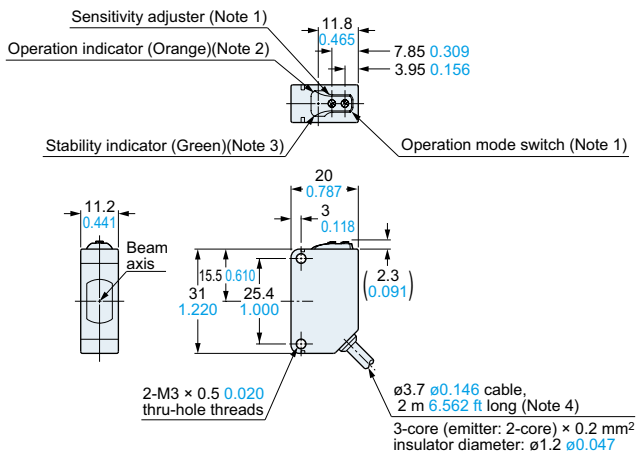

- Notes: 1) Not incorporated on the emitter and the basic type sensor.
 2) It is the power indicator (green) on the emitter.
 3) Not incorporated on the emitter.
 4) Basic type: 0.5 m 1.640 ft long

CX-41-Z Sensor

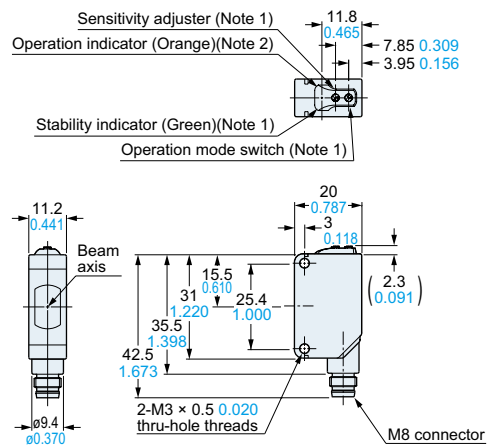

- Notes: 1) Not incorporated on the emitter.
 2) It is the power indicator (green) on the emitter.

CX-41-J Sensor

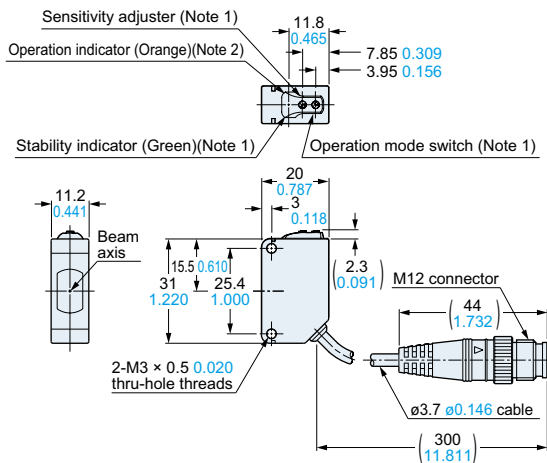

- Notes: 1) Not incorporated on the emitter.
 2) It is the power indicator (green) on the emitter.

CX-49 CX-48 CX-42 Sensor

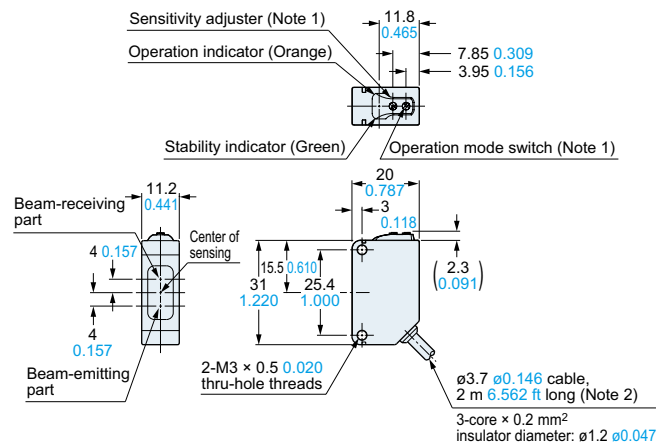

- Notes: 1) Not incorporated on the Basic type sensors.
 2) Basic type: 0.5 m 1.640 ft long

CX-49-Z CX-48-Z CX-42-Z Sensor

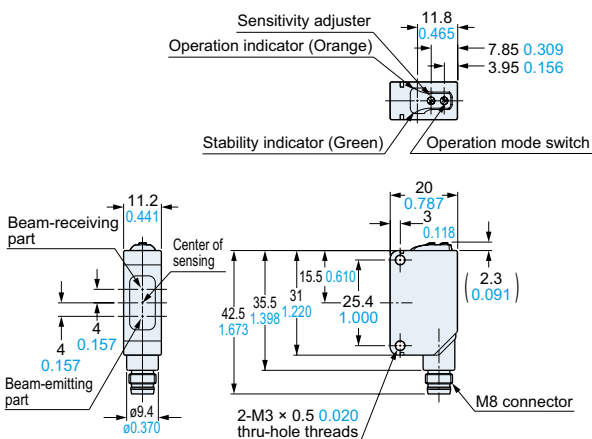

CX-49-J CX-48-J CX-42-J Sensor

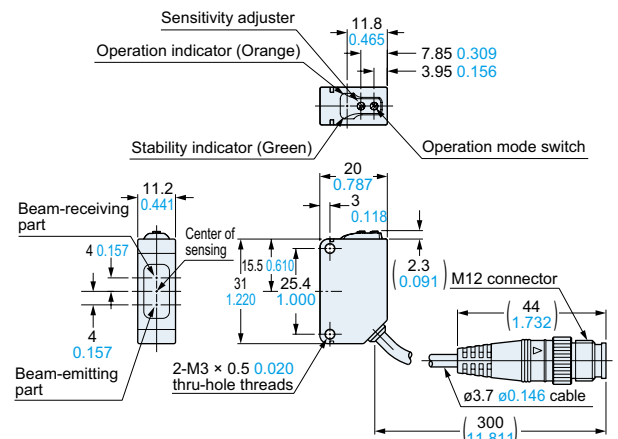

| |
|---|
| FIBER SENSORS |
| LASER SENSORS |
| PHOTO-ELECTRIC SENSORS |
| MICRO PHOTO-ELECTRIC SENSORS |
| AREA SENSORS |
| SAFETY LIGHT CURTAINS / SAFETY COMPONENTS |
| PRESSURE / FLOW SENSORS |
| INDUCTIVE PROXIMITY SENSORS |
| PARTICULAR USE SENSORS |
| SENSOR OPTIONS |
| SIMPLE WIRE-SAVING UNITS |
| WIRE-SAVING SYSTEMS |
| MEASUREMENT SENSORS |
| STATIC CONTROL DEVICES |
| LASER MARKERS |
| PLC |
| HUMAN MACHINE INTERFACES |
| ENERGY MANAGEMENT SOLUTIONS |
| FA COMPONENTS |
| MACHINE VISION SYSTEMS |
| UV CURING SYSTEMS |
| Selection Guide |
| Amplifier Built-in |
| Power Supply Built-in |
| Amplifier-separated |
| EX-Z |
| CX-400 |
| CY-100 |
| EX-10 |
| EX-20 |
| EX-30 |
| EX-40 |
| CX-440 |
| EQ-30 |
| EQ-500 |
| MQ-W |
| RX-LS200 |
| RX |
| RT-610 |

DIMENSIONS (Unit: mm in)

The CAD data can be downloaded from our website.

FIBER SENSORS

LASER SENSORS

PHOTO-ELECTRIC SENSORS
MICRO PHOTO-ELECTRIC SENSORS

AREA SENSORS

SAFETY LIGHT CURTAINS / SAFETY COMPONENTS

PRESSURE / FLOW SENSORS

INDUCTIVE PROXIMITY SENSORS

PARTICULAR USE SENSORS

SENSOR OPTIONS

SIMPLE WIRE-SAVING UNITS

WIRE-SAVING SYSTEMS

MEASURE-MENT SENSORS

STATIC CONTROL DEVICES

LASER MARKERS

PLC

HUMAN MACHINE INTERFACES

ENERGY MANAGEMENT SOLUTIONS

FA COMPONENTS

MACHINE VISION SYSTEMS

UV CURING SYSTEMS

Selection Guide

Amplifier Built-in
Power Supply Built-in

Amplifier-separated

EX-Z

CX-400

CY-100

EX-10

EX-20

EX-30

EX-40

CX-440

EQ-30

EQ-500

MQ-W

RX-LS200

RX

RT-610

CX-44□ Sensor

CX-44□-Z Sensor

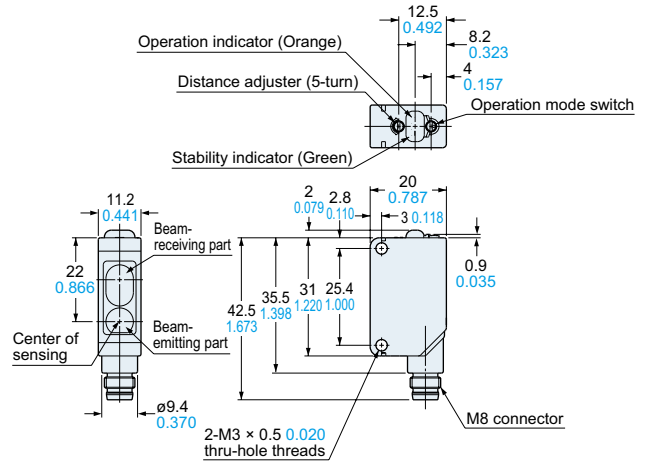
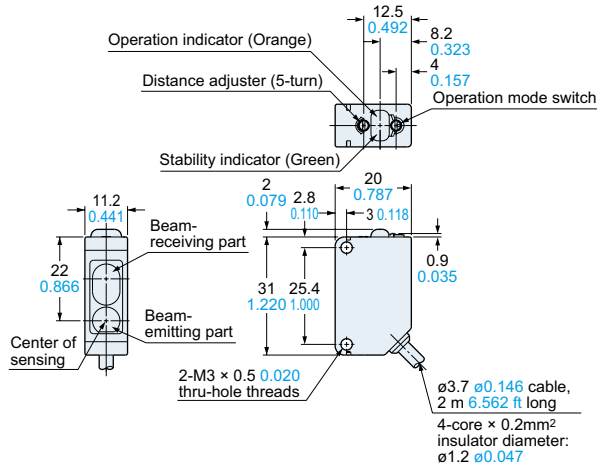

RF-230 Reflector (Accessory for the retroreflective type sensor)

RF-220 Reflector (Optional)

RF-210 Reflector (Optional)

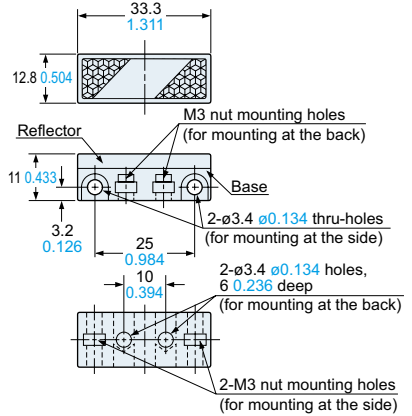
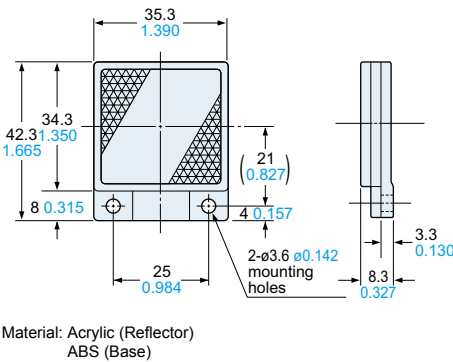
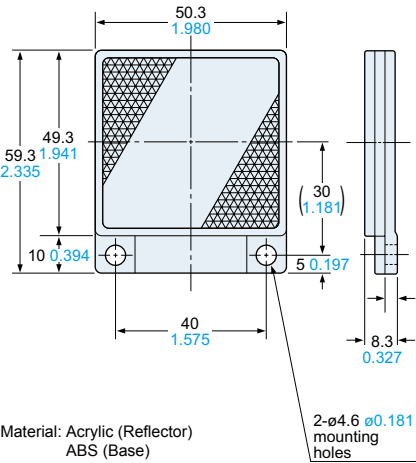

Material: Acrylic (Reflector)
ABS (Base)

Material: Acrylic (Reflector)
ABS (Base)

Two M3 (length 8 mm 0.315 in) screws with washers and two nuts are attached.

Note: It is not attached with the basic type sensor.

RF-11 Reflective tape (Optional)

RF-12 Reflective tape (Optional)

RF-13 Reflective tape (Optional)

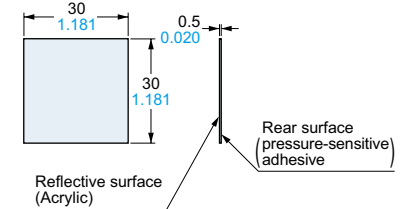
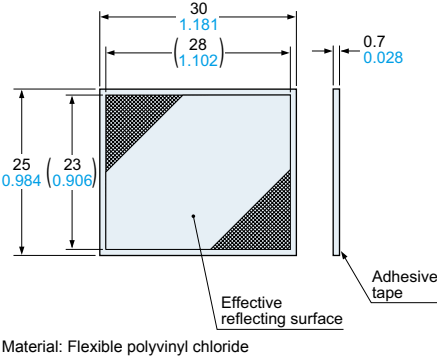
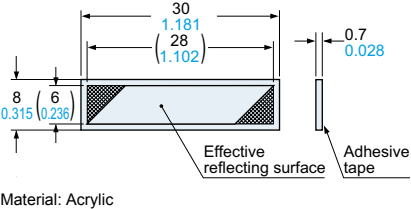

Material: Acrylic

Material: Flexible polyvinyl chloride

DIMENSIONS (Unit: mm in)

The CAD data can be downloaded from our website.

- FIBER SENSORS
- LASER SENSORS
- PHOTO-ELECTRIC SENSORS
- MICRO PHOTO-ELECTRIC SENSORS
- AREA SENSORS
- SAFETY LIGHT CURTAINS / SAFETY COMPONENTS
- PRESSURE / FLOW SENSORS
- INDUCTIVE PROXIMITY SENSORS
- PARTICULAR USE SENSORS
- SENSOR OPTIONS
- SIMPLE WIRE-SAVING UNITS
- WIRE-SAVING SYSTEMS
- MEASURE-MENT SENSORS
- STATIC CONTROL DEVICES
- LASER MARKERS
- PLC
- HUMAN MACHINE INTERFACES
- ENERGY MANAGEMENT SOLUTIONS
- FA COMPONENTS
- MACHINE VISION SYSTEMS
- UV CURING SYSTEMS
- Selection Guide
- Amplifier Built-in
- Power Supply Built-in
- Amplifier-separated
- EX-Z**
- CX-400**
- CY-100**
- EX-10**
- EX-20**
- EX-30**
- EX-40**
- CX-440**
- EQ-30**
- EQ-500**
- MQ-W**
- RX-LS200**
- RX**
- RT-610**

MS-CX2-5

Sensor mounting bracket (Optional)

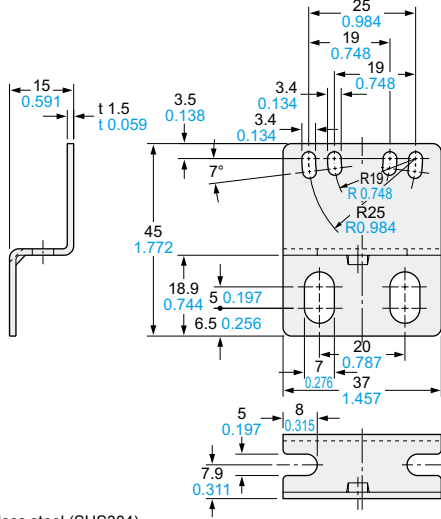

Material: Stainless steel (SUS304)

Two M3 (length 12 mm 0.472 in) screws with washers are attached.

Assembly dimensions

Mounting drawing with the receiver of **CX-41** □

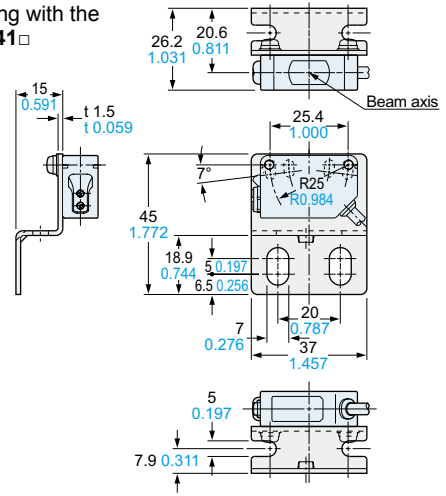

MS-CX-3

Sensor mounting bracket (Optional)

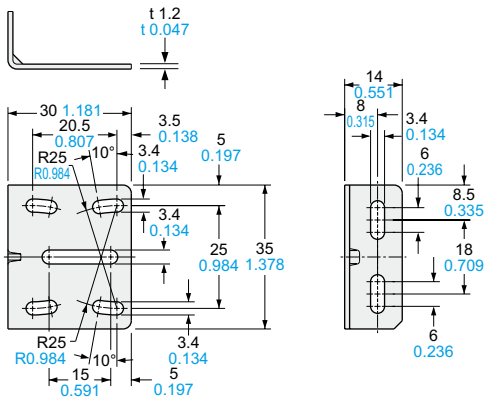

Material: Stainless steel (SUS304)

Two M3 (length 12 mm 0.472 in) screws with washers are attached.

Assembly dimensions

Mounting drawing with the receiver of **CX-41** □

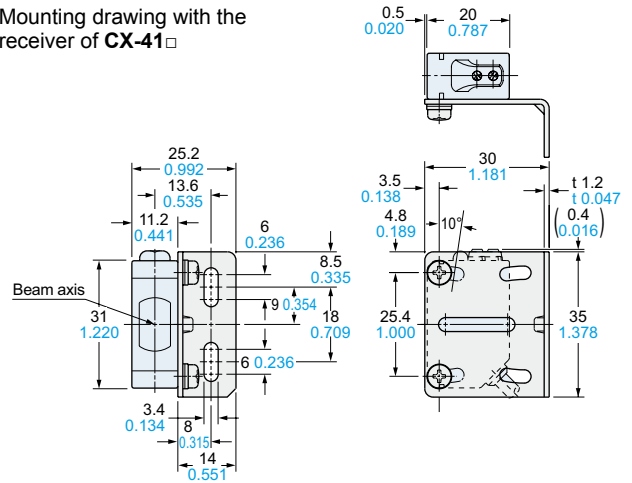

DIMENSIONS (Unit: mm in)

The CAD data can be downloaded from our website.

MS-RF21-1

Reflector mounting bracket for RF-210 (Optional)

Assembly dimensions

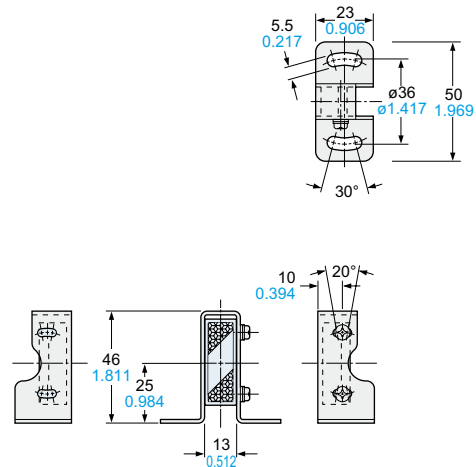
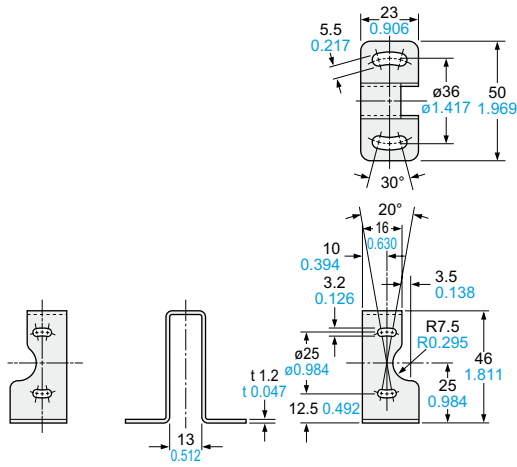

Material: Stainless steel (SUS304)
Two M3 (length 12 mm 0.472 in) screws with washers are attached.

MS-RF22

Reflector mounting bracket for RF-220 (Optional)

Assembly dimensions

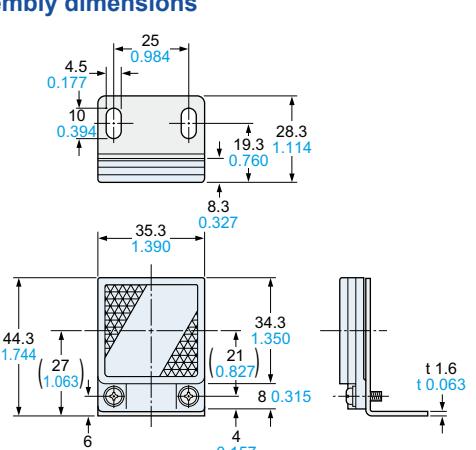
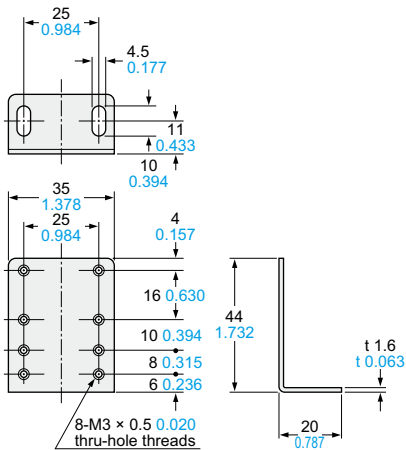

Material: Cold rolled carbon steel (SPCC)
(Uni-chrome plated)
Two M3 (length 8 mm 0.315 in) screws with washers are attached.

MS-RF23

Reflector mounting bracket for RF-230 (Optional)

Assembly dimensions

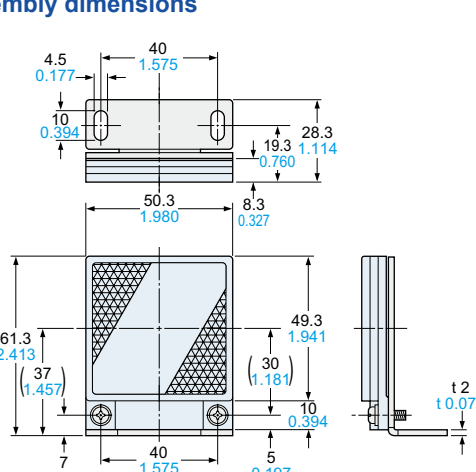
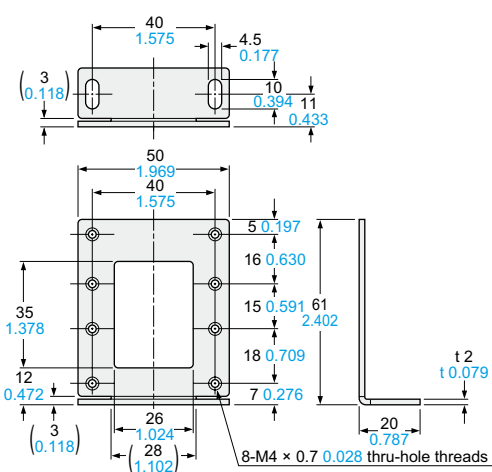

Material: Cold rolled carbon steel (SPCC)
(Uni-chrome plated)
Two M4 (length 10 mm 0.394 in) screws with washers are attached.

FIBER SENSORS

LASER SENSORS

PHOTO-ELECTRIC SENSORS

MICRO PHOTO-ELECTRIC SENSORS

AREA SENSORS

SAFETY LIGHT CURTAINS / SAFETY COMPONENTS

PRESSURE / FLOW SENSORS

INDUCTIVE PROXIMITY SENSORS

PARTICULAR USE SENSORS

SENSOR OPTIONS

SMALL WIRE-SAVING UNITS

WIRE-SAVING SYSTEMS

MEASUREMENT SENSORS

STATIC CONTROL DEVICES

LASER MARKERS

PLC

HUMAN MACHINE INTERFACES

ENERGY MANAGEMENT SOLUTIONS

FA COMPONENTS

MACHINE VISION SYSTEMS

UV CURING SYSTEMS

Selection Guide

Amplifier Built-in

Power Supply Built-in

Amplifier-separated

EX-Z

CX-400

CY-100

EX-10

EX-20

EX-30

EX-40

CX-440

EQ-30

EQ-500

MQ-W

RX-LS200

RX

RT-610