

W-series reels are designed for extreme space-restricted applications. Perfect for under work bench mounting, can be mounted on ceiling or wall.

### SUS Equipped with SUS protector

Stainless Steel protector has been added at hose outlet to extend life of outside casing.

### Improved support strength

Strengthened bracket support arms more than twice of previous model.



### Winner of Good Design Award in 2008.

Unique Frame Design for wall installation. New Standard of our TRIENS Brand.

#### Ceiling or Wall mount



#### Dimensions

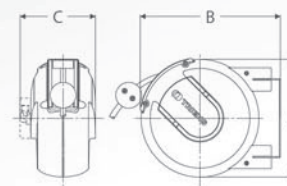

#### Mounting Bracket dimensions (mm)

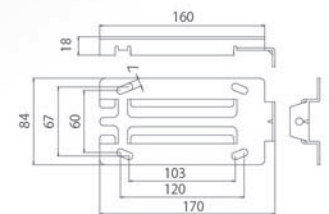

### Air Hose Reels



Air Hose Reel  
**WHC-206** **6.5mm** **6m**  
•High quality polyurethane hose •Easy coupling

Model	Outlet Hose				MPa	Inlet Hose		Dimensions (mm)			Weight (kg)
	I.D. (mm)	m	Outlet	hose		m	Inlet	A	B	C	
WHC-206	6.5	6	Female G1/4	PU	1.4	0.8	Swivel fitting male R1/4	228	272	146	2.7
WHC-303	8.0	3	Female Rc3/8	PU	1.4	1.0	Swivel fitting male R3/8	228	272	146	2.8

comes with mounting base set

Air Hose Reel  
**WHC-303** **8.0mm** **3m**  
•High quality polyurethane hose

### Outlet Cord Reels



Outlet Cord Reel  
**WCC-306** **100V** **220V** **6m**

Model	Outlet Cord			Power Rating		Inlet Cord		Dimensions (mm)			Weight (kg)
	Wire	m	Outlet			m	Inlet	A	B	C	
WCC-306A	1.5×3	6.1	Type E Socket	AC125V/6A	AC250V/6A	0.8	Type E Plug	228	272	147	3.0

comes with mounting base set

### Control Switch Reel



Control Switch Reel  
**WPC-406** **4 cores** **6m**

Model	Outlet Cord			Power Rating		Inlet Cord		Dimensions (mm)			Weight (kg)
	Wire	m	Outlet			m	Inlet	A	B	C	
WPC-406	2.0×4	6	soldered wires	AC125V/6A	AC250V/5A	0.8	Bullet terminal	228	272	147	3.1

Comes with mounting base set

# W-series

Unique Design with innovative level wind mechanism

Extreme compact width and height compared to previous models

Robust supporting arms are especially designed for wall mounting position

A new streamlined design that symbolizes the series

Introduces a level wind mechanism that prevents tangling

Ceiling or wall mount available



## Ceiling or Wall mount



## 60 Degrees pivoting

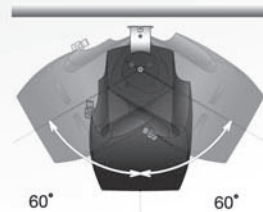

## Dimensions

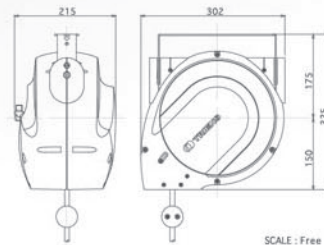

## Mounting Bracket dimensions

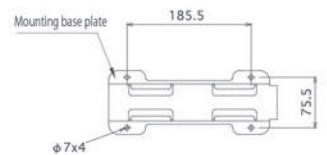

## Air Hose Reels



Air Hose Reels  
**WHS-215** 6.5 mm **15m**  
**WHS-310** 8.0 mm **10m**

Anti-spark Hose Reels  
**WHS-215S** 6.5 mm **15m**  
**WHS-310S** 8.0 mm **10m**

Model	Outlet Hose		MPa	Inlet Hose		Dimensions (mm)			Weight (kg)		
	I.D. (mm)	m		Outlet hose	Inlet	A	B	C			
WHS-215	6.5	15	Female G1/4	PU	1.4	0.8	Swivel Fitting Male R1/4	325	300	214	8.6
WHS-310	8.0	10	Female Rc3/8	PU	1.4	1.0	Swivel Fitting Male R3/8	325	300	214	8.7
WHS-215S	6.5	15	Female G1/4	Anti-spark	1.4	0.8	Swivel Fitting Male R1/4	325	300	214	8.6
WHS-310S	8.0	10	Female Rc3/8	Anti-spark	1.4	1.0	Swivel Fitting Male R3/8	325	300	214	8.7

comes with mounting base set

\*Inlet hose is not anti-spark hose.

## Outlet Cord Reels



Outlet Cord Reels  
**WCS-315** 100V 220V **15m**

Model	Outlet Cord		Power Rating		Inlet Cord		Dimensions (mm)			Weight (kg)
	Wire	m	Outlet		Inlet		A	B	C	
WCS-315	1.5x3	15	Type E Socket	AC125V/6A AC250V/6A	0.8	Type E Plug	325	300	214	9.2

comes with mounting base set

# T-series

Reliability and Results. TRIENS' new redesigned standard series

Light weight, easy to handle and convenient for restricted indoor spaces. High impact cover protects all working parts from contaminants, such as dust or dirt, and prevents hose binding and overlap.

\* Corrosion resistant solid brass axle.

\* Reel comes complete with inlet hose or cord, and mounting bracket.



Small



Medium



Won the prize Good Design Awards 2006 Product design Section

Auto rewind Air Hose Reel and Outlet Cord Reel were awarded for the Good Design Award product design section.

### 2 ways of mounting

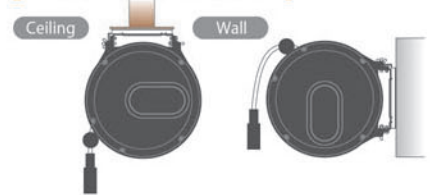

mounting base

(mm)

### Dimensions

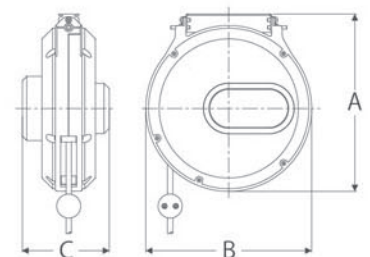
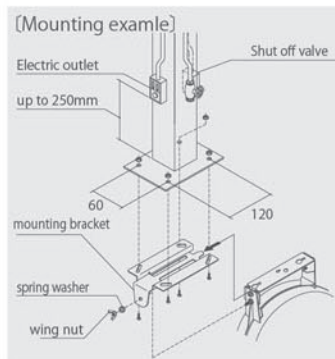
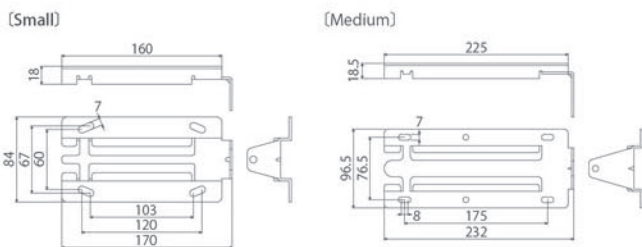

## Air Hose Reels (small)



Air Hose Reel  
**THS-210** 65 mm **10m**

- High-quality polyurethane hose
- Easy coupling



Limber Hose Reel  
**THS-210S** 65 mm **10m**

- Anti-Spark flexible hose
- Easy coupling

Model	Outlet Hose				MPa	Inlet Hose		Dimensions (mm)			Weight (kg)
	I.D.(mm)	m	Outlet	Hose		m	Inlet	A	B	C	
THS-210	6.5	10	Female G1/4	PU	1.4	0.8	Swivel Fitting Male R1/4	332	310	163	3.8 / 3.9
THS-210S	6.5	10	Female G1/4	Anti-spark	1.4	0.8	Swivel Fitting Male R1/4	332	310	163	3.8 / 3.9

Comes with mounting base set

※Inlet hose is not Anti-spark type.

## Air Hose Reels (Medium)



Air Hose Reel  
**THM-310** 8.0 mm **10m**

Air Hose Reel  
**THM-215** 6.5 mm **15m**

- High-quality polyurethane hose
- Easy coupling.

Air Hose Reel  
**THM-315** 8.0 mm **15m**

Air Hose Reel  
**THM-220** 6.5 mm **20m**



Limber Hose Reel  
**THM-310S** 8.0 mm **10m**

Limber Hose Reel  
**THM-215S** 6.5 mm **15m**

- Anti-spark flex hose.
- Easy coupling

Limber Hose Reel  
**THM-315S** 8.0 mm **15m**

Limber Hose Reel  
**THM-220S** 6.5 mm **20m**

Model	Outlet Hose				MPa	Inlet Hose		Dimensions (mm)			Weight (kg)
	I.D.(mm)	m	Outlet	Hose		m	Inlet	A	B	C	
THM-310	8.0	10	Female Rc3/8	PU	1.4	1.0	Swivel fitting Male R3/8	440	397	195	7.0
THM-315	8.0	15	Female Rc3/8	PU	1.4	1.0	Swivel fitting Male R3/8	440	397	195	7.4
THM-215	6.5	15	Female G1/4	PU	1.4	0.8	Swivel fitting Male R3/8	440	397	195	7.0
THM-220	6.5	20	Female G1/4	PU	1.4	0.8	Swivel fitting Male R3/8	440	397	195	7.3
THM-310S	8.0	10	Female Rc3/8	Anti-Spark	1.4	1.0	Swivel fitting Male R3/8	440	397	195	7.0
THM-315S	8.0	15	Female Rc3/8	Anti-Spark	1.4	1.0	Swivel fitting Male R3/8	440	397	195	7.4
THM-215S	6.5	15	Female G1/4	Anti-Spark	1.4	0.8	Swivel fitting Male R3/8	440	397	195	7.0
THM-220S	6.5	20	Female G1/4	Anti-Spark	1.4	0.8	Swivel fitting Male R3/8	440	397	195	7.3

Comes with mounting base set

※inlet hose is not Anti-spark type.

## Water Reels



Water Reel  
**TWS-208** 6.0 mm **8m**

- Reliable PVC hose



Water Reel  
**TWM-310** 8.0 mm **10m**

- Reliable PVC hose

Model	Outlet Hose				MPa	Inlet Hose		Dimensions (mm)			Weight (kg)
	I.D.(mm)	m	Outlet	hose		m	Inlet	A	B	C	
TWS-208	6.0	8	Female G1/4(w/O-ring)	PVC	1.4	0.8	Male R1/4	332	310	163	3.9
TWM-310	8.0	10	Female Rc3/8	PVC	1.4	1.0	Male R3/8	440	397	195	7.0

comes with mounting base set

 Outlet Cord Reels(small)



Output Cord Reel  
TCS-310 100V 220V 10m

Model	Outlet Cord		Power Rating		Inlet Cord		Dimensions (mm)			Weight (kg)
	Wire	m	Outlet		m	Inlet	A	B	C	
TCS-310	1.5×3	10	Socket (w/ground clip)	AC125V/6A AC250V/6A	0.8	Plug (w/ground clip)	332	310	150	4.2

Comes with mounting base set

 Outlet Cord Reels(medium)



Outlet Cord Reel  
TCM-315 100V 220V 15m

Outlet Cord Reel  
TCM-320 100V 220V 20m

Model	Outlet Cord		Power Rating		Inlet Cord		Dimensions (mm)			Weight (kg)
	Wire	m	Outlet		m	Inlet	A	B	C	
TCM-315	1.5×3	15	Socket (w/ground clip)	AC125V/6A AC250V/6A	0.8	Plug (w/ground clip)	440	397	168	7.2
TCM-320	1.5×3	20	Socket (w/ground clip)	AC125V/6A AC250V/6A	0.8	Plug (w/ground clip)	440	397	168	7.8

Comes with mounting base set

Plug/Socket option

A / A3

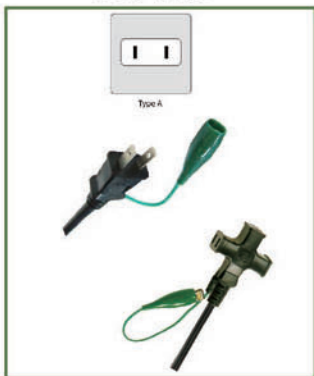

EF / E



G / G



B / B



 Outlet Cord Reels with light(small)



Captain Light Reel  
TCS-310C

100V 220V 10m

- Outlet Cord Reel with Captain light (18W hand light.)



Captain Light Reel  
TCS-310D

100V 220V 10m

- Outlet Cord Reel with Captain light LED (18W LED hand light.)

Model	Outlet Cord		Power Rating		Inlet Cord		Dimensions (mm)			Weight (kg)
	Wire	m	Outlet		m	Inlet	A	B	C	
TCS-310C	1.5×3	10	Hand light	AC125V/6A AC250V/6A	0.8	Plug (w/ground clip)	332	310	150	4.6
TCS-310D	1.5×3	10	LED Hand light	AC125V/6A AC250V/6A	0.8	Plug (w/ground clip)	440	397	168	7.7

Comes with mounting base set

 Outlet Cord Reels with light(medium)



Captain Light Reel  
TCM-315C

100V 220V 15m

- Outlet Cord Reel with Captain light (18W hand light.)

Captain Light Reel  
TCM-320C

100V 220V 20m

- Outlet Cord Reel with Captain light (18W hand light.)



Captain Light Reel  
TCM-315D

100V 220V 15m

- Outlet Cord Reel with Captain light LED (18W LED hand light.)

Captain Light Reel  
TCM-320D

100V 220V 20m

- Outlet Cord Reel with Captain light LED (18W LED hand light.)

Model	Outlet Cord		Power Rating		Inlet Cord		Dimensions (mm)			Weight (kg)
	Wire	m	Outlet		m	Inlet	A	B	C	
TCM-315C	1.5×3	15	Hand light	AC125V/6A AC250V/6A	0.8	Plug (w/ground clip)	440	397	168	7.7
TCM-320C	1.5×3	20	Hand light	AC125V/6A AC250V/6A	0.8	Plug (w/ground clip)	440	397	168	8.2
TCM-315D	1.5×3	15	LED Hand light	AC125V/6A AC250V/6A	0.8	Plug (w/ground clip)	440	397	168	7.7
TCM-320D	1.5×3	20	LED Hand light	AC125V/6A AC250V/6A	0.8	Plug (w/ground clip)	440	397	168	8.2

Comes with mounting base set



CL-18



CL-18LED

Replacement  
fluorescent  
lamp unit (for CL-18)



PLL-18W

Replacement LED  
lamp unit  
(for CL-18LED)



LED-18

Hand light line up

Model	length(m)	Power rating		dissipation	Dimensions (mm)			Weight(g)
CL-18	0.22	AC125V/6A	AC250V/6A	18W	350	65	42	395
CL-1805	5	AC125V/6A	AC250V/6A	18W	350	65	42	425
CL-1810	10	AC125V/6A	AC250V/6A	18W	350	65	42	825
CL-18LED	0.22	AC125V/6A	AC250V/6A	7W	350	65	42	415
CL-1805LED	5	AC125V/6A	AC250V/6A	7W	350	65	42	445
CL-1810LED	10	AC125V/6A	AC250V/6A	7W	350	65	42	845